



**Print Area**



# CONTENTS

- UV Offset Printing Ink
- YT-660 Gloss / YT-500 Matt
- UV Drip off Varnish / UV Drip off Primer
- UV Flexo Printing Ink
- YY-588 UV Varnish / YY-609 UV Varnish
- Pantone Spot Color Series
- Auxiliary Ink
- Soy Bean Offset Printing Ink
- Security Ink
- Screen Ink & Fabric Ink
- Metal Decorating Ink & Water Base Ink
- Printing Blanket
- Hot Melt Adhseive
- Printing Material
- Printing Chemical
- Printing Spare Part
- Air Filter / Double Wire





# UV Offset Printing Ink

Generally used for paper printing.

310-UV

310-LED



# UV Offset Printing Ink

Generally used for paper and film(PP,PE,PVC).

316-UV

316-LED





# UV Varnish



YY-588 UV Varnish (Coated)



YY-609 UV Varnish (Not Coated)

## Application



## Production Workshop





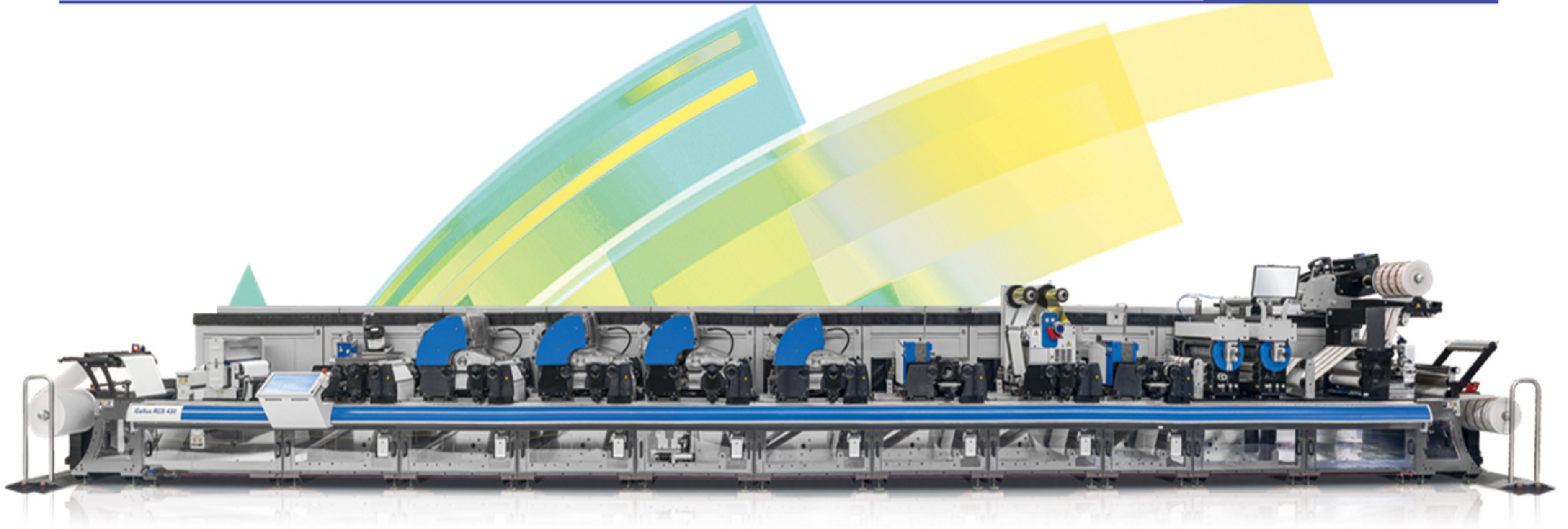

## UV Flexo Ink

Stronger ink transfer performance, higher color strength, and better printing density, high-definition dots, text and solids are obtained when printing on high screen line.

### Features

1. High color strength, 10-15% higher than ordinary ink.
2. Lower odor, suitable for odor-sensitive product packaging such as food cosmetics.
3. Good curing performance, suitable for high speed printing.
4. Suitable for various doctor blade systems.
5. Lower viscosity and more stable and consistent viscosity.
6. Excellent combination printing.
7. Excellent printability and dot reproduction.
8. Wide range of applicable materials, good adhesion to materials.
9. Less printing and absorption on paper materials.

### Application range

1. In-membrane label 2. Wrapping tags 3. Various non-absorbent materials 4. Sticker  
Notes: Hot stamping and thermal transfer embossing

### Four Colors Process





Features	Advantage
In-membrane label	Low ink consumption for high-quality printing
Low viscosity	Good ink flow and good transfer performance
Environmentally friendly raw materials, lower odor	More suitable for food/cosmetic packaging and labeling
Excellent printing stability	Consistent print quality
Clear screen dots and text can be obtained at the same time when printing on high screen lines	Enables flexographic printing to produce high-quality prints
Wide range of materials used, good product resistance	Able to meet the different use requirements of various products
Higher curing speed	More suitable for high-speed printing and increase yield
Good combination printing performance	Improve combined printing yield

## Notes

- Available in four colors and Pantong basic colors
- Hexachrome six-color basic colors are also available

## PANTONE SPOT COLOR SERIES

021C Orange	Warm Red
Rubine Red	Rhodamine
Green	Purple
Violet	Reflex Blue
072C Blue	032C Red



## YT-02 Ink **High Brightness**

- High gloss and color density
- Quick dry, stability on printing press
- Rich layering, good reappearance of half-tones
- Water and rub resistance
- Low odor and non-skin irritation

### Production Workshop



## YT-03 Ink **Quick Drying**

- High gloss and density of color
- Fast drying, stability on printing press Rich layering, good reappearance
- Water and rub resistance Conforming to the standards of EN71-3, RoHS
- Eco-friendly ink for offset printing ,soy based ink

### Ink on the Machine





## YT-09 Ink **Eco-friendly Ink**

- High gloss and color density
- Quick dry, stability on printing press
- Low odor and non-skin irritation
- Water and rub resistance
- Conforming to the standards of EN71-3, RoHS
- Rich layering, good reappearance of half-tones
- Matching color as customer request
- Excellent offset printing ink for offset printing

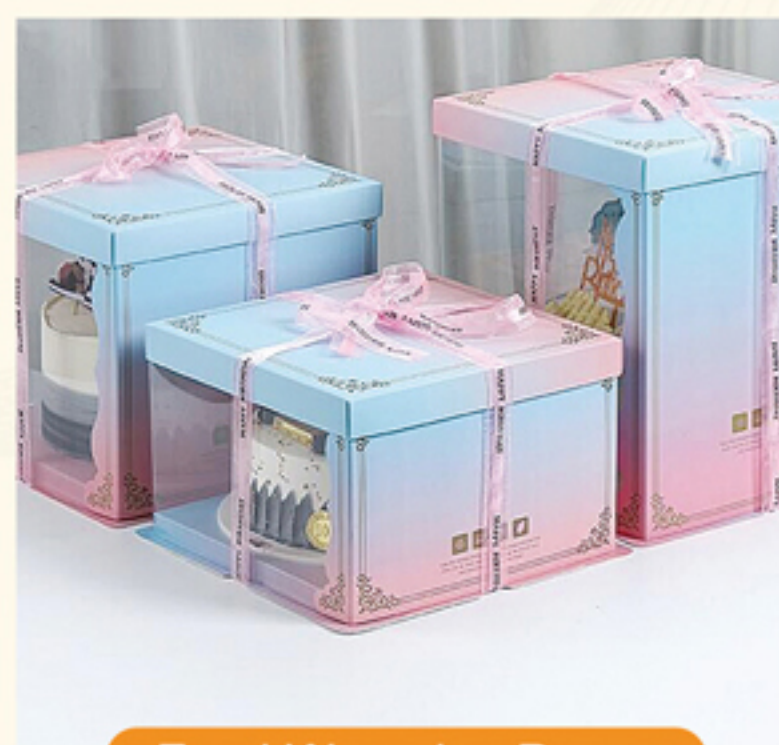

Food Wrapping Paper



Children's Book

## YT-06 Ink **Melamine Ink**

- Heat and sunlight resistance
- Holding color and hard to bleeding color
- Higher density of color
- Brilliant on the thinner coatings
- Conforming to the stands of EN71-3, RoHS
- Low odor and non-irritation
- High-definition multiple printing stocks



## A-1 Ink **Economic ink**

- High Gloss
- High Color Density and Quick Dry
- Water and Rub Resistance
- Economy



# Pantone Spot Color Series

-  Reflex Blue
-  Warm Red
-  Orange 021C
-  Green
-  Ultramarine Blue
-  Rhodamine Red
-  Rubine Red
-  Purple
-  Violet
-  Red 032C
-  Blue 072C
-  Process Blue
-  Special Black
-  White
-  Reflex Blue\*(This ink will not change color.)





## YT-500 Matt OP Varnish

- Excellent matt effect
- Fast drying
- High transparency



## YT-660 Gloss OP Varnish

- Higher mirror surface effect and fast drying.
- High transparency and tenacity and not easy to turn yellow.



## The Best Partner



**Ceres 200**  
UV Drip off Primer



**Ceres 100**  
UV Drip off Varnish

### Features

- 1.Go directly hot stamping after printing.
- 2.Exquisit line 0.10mm perfect performance.
- 3.Lines interval could be controlled to a minimum 0.10mm.

• Low Odor,Good Flexibility.

• Reduce the production cost,earn more profits.



# Auxiliary Offset Ink

Description	Feature	Packaging	Picture
<p><b>YT-300</b> Primer Coating for Paper</p>	<ul style="list-style-type: none"> <li>• Remedy the power dropping, wrinkle and other quality problem of the paper.</li> <li>• Improve printing quality</li> </ul>	<p>2.5Kg/Can 6Cans/Carton</p>	
<p><b>YT-500</b> Matt OP Varnish</p>	<ul style="list-style-type: none"> <li>• Excellent matt effect</li> <li>• Fast drying</li> <li>• High transparency</li> </ul>	<p>2.5Kg/Can 6Cans/Carton</p>	
<p><b>YT-660</b> Gloss OP Varnish</p>	<ul style="list-style-type: none"> <li>• Higher mirror surface effect and fast drying.</li> <li>• High transparency and tenacity and not easy to turn yellow.</li> </ul>	<p>2.5Kg/Can 6Cans/Carton</p>	
<p><b>YT-901</b> Clear Medium</p>	<ul style="list-style-type: none"> <li>• High transparency and gloss</li> <li>• Not easy to yellow</li> </ul>	<p>2.5Kg/Can 6Cans/Carton</p>	
<p><b>YT-902</b> JellyCompound</p>	<ul style="list-style-type: none"> <li>• Reduce the viscosity of the ink efficiently.</li> <li>• Transparent jelly condition.</li> </ul>	<p>2Kg/Can 6Cans/Carton</p>	
<p><b>YT-903</b> Varnish</p>	<ul style="list-style-type: none"> <li>• Reduce the viscosity of the ink efficiently.</li> <li>• Promote the glosses and fast drying.</li> </ul>	<p>3Kg/Can</p>	



# Optical Variable Ink

**Printing method:** Screen printing / Flexo printing

**Applications:** Paper, cloth, metal, glass, ceramics, plastic and so on. Such as: currency, passport, card, tobacco, alcohol, drugs, cosmetics labels, packaging and other printed matter with high anti-counterfeiting requirements.



# UV Invisible Ink

**Printing method:** Screen printing, offset printing, flexo printing and inkjet

**Applications:** Mainly used in currency, bills, cards, cosmetics labels, packaging, etc.

Longwave(356) Red Shortwave(256) Yellow





# Temperature Sensitive Ink

Printing method: Screen printing

Suitable material: Paper, cloth, plastic, metal

(Remark: Temperature sensitive inks are reversible and irreversible)

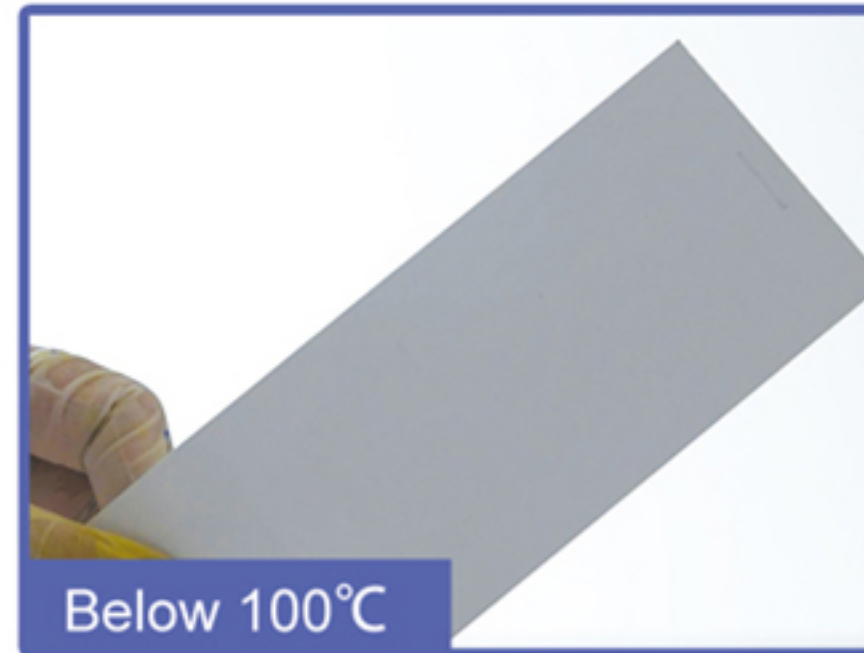

# Fragrance Ink

Printing method: Screen printing and offset printing

Application: Greeting cards, postcards, children's books, tissue, etc.



# Scratch Off Ink



Printing method: Screen printing

Applications: Mainly used for confidential documents, code security signs, lottery tickets, lottery cards and so on.





# Photochromic Ink

**Printing method:** Screen printing

**Suitable material:** Metal, cloth, paper

**Specification:** The ink in the dark light display for a specific color, after sunlight the ink into another color, in the dark light to restore the original color.



Outdoor

Indoor



Indoor



Outdoor

# Glow In Dark Ink

**Printing method:** Screen printing

**Application:** Electrical switch, warning signal, crafts, clothing, paper, etc



In the Daylight



In the Dark

# Magnetic Ink

**Printing method:** Screen printing/offset printing

**Application:** Mainly used in ticket, printing, bank passbook, ID card and other magnetic card printing security.





## Water Sensitive Ink

**Printing method:** Screen printing

**Applicable material:** Water cloth, umbrella, children's book, sticker label.



Before the water



After the water

## Water Diffusion Ink

**Printing method:** Screen printing

**Application:** Water Diffusion Ink is irreversible. Generally used for water detection or authenticity detection of electronic products.



Before the water



After the water

## Watermark Ink

**Printing method:** Screen printing and offset printing

**Applications:** Mainly used for books, manuals, warranty cards, certificates, invoices security.



White



Black



# Conductive Ink

**Printing method:** Screen printing

**Application:** Used for printing circuits, electrodes, electroplating substrate, keyboard contacts, printing resistors and other materials

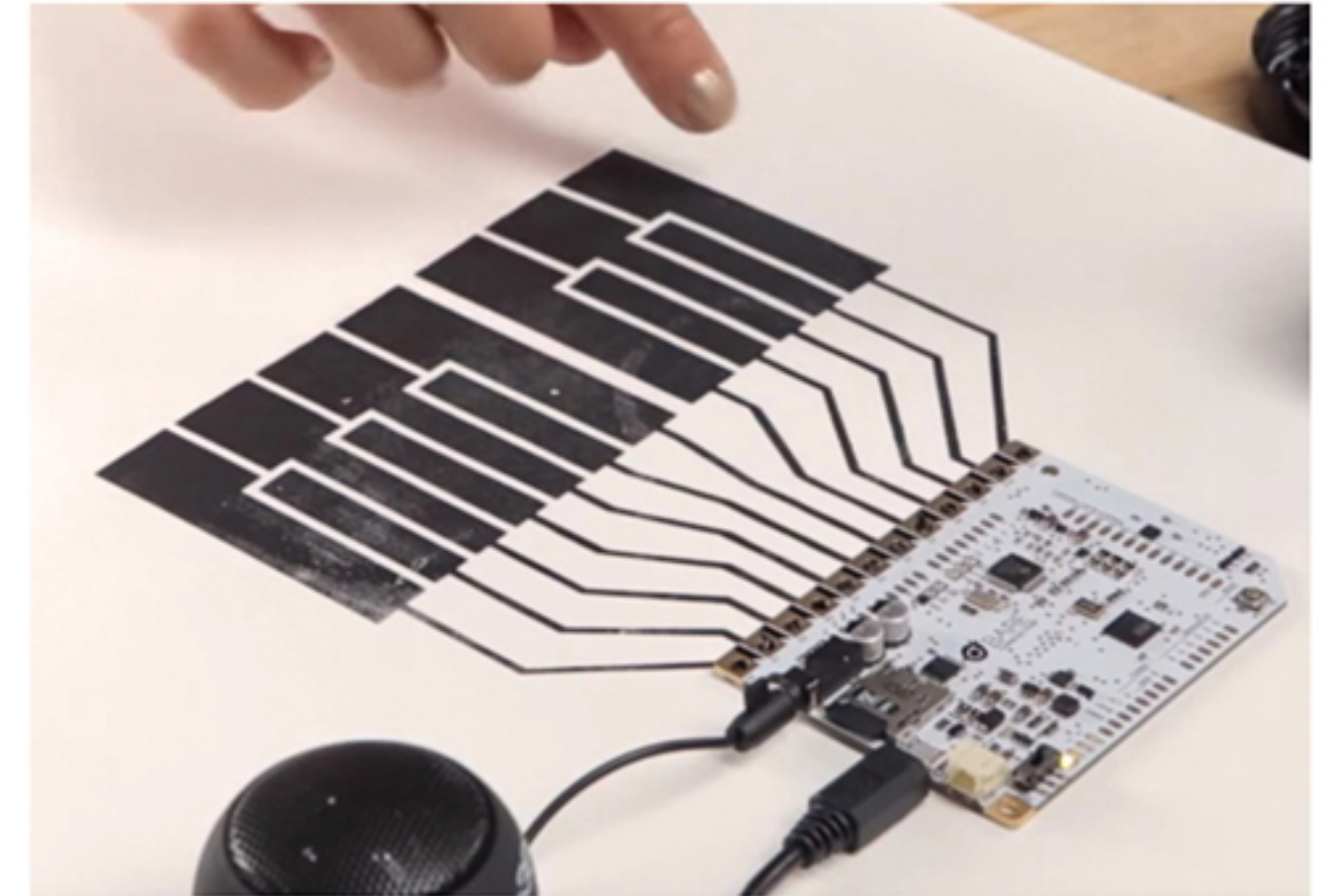

# Laser Ink

**Features:** Excellent adhesion, covering power, good wear resistance, full and beautiful color.



# Reflective Ink

**Features:** Good scratch resistance, high hiding power and good adhesion



# Mirror Ink

**Application:** Mirror ink is printed on transparent plastic sheets and glass, such as PC, PET, PVC and PMMA.



We could produce all kinds of security inks, such as UV Invisible Ink, Optical Variable Ink, Temperature Sensitive Ink, Photochromic Ink, Water Sensitive Ink, Watermark Ink, Water Diffusion Ink etc.

More security ink, please feel free to consult us!



# Security paper

It is mainly used in the government offices, certificates, lottery, bills, real estate contract, education department, famous brand food and clothing, medicine, cosmetics, tobacco, tea, wine, publishing industry, and so on. The security features with high-anti-counterfeiting, safety and strong confidentiality.

## Watermark Paper



## Color Fiber Paper

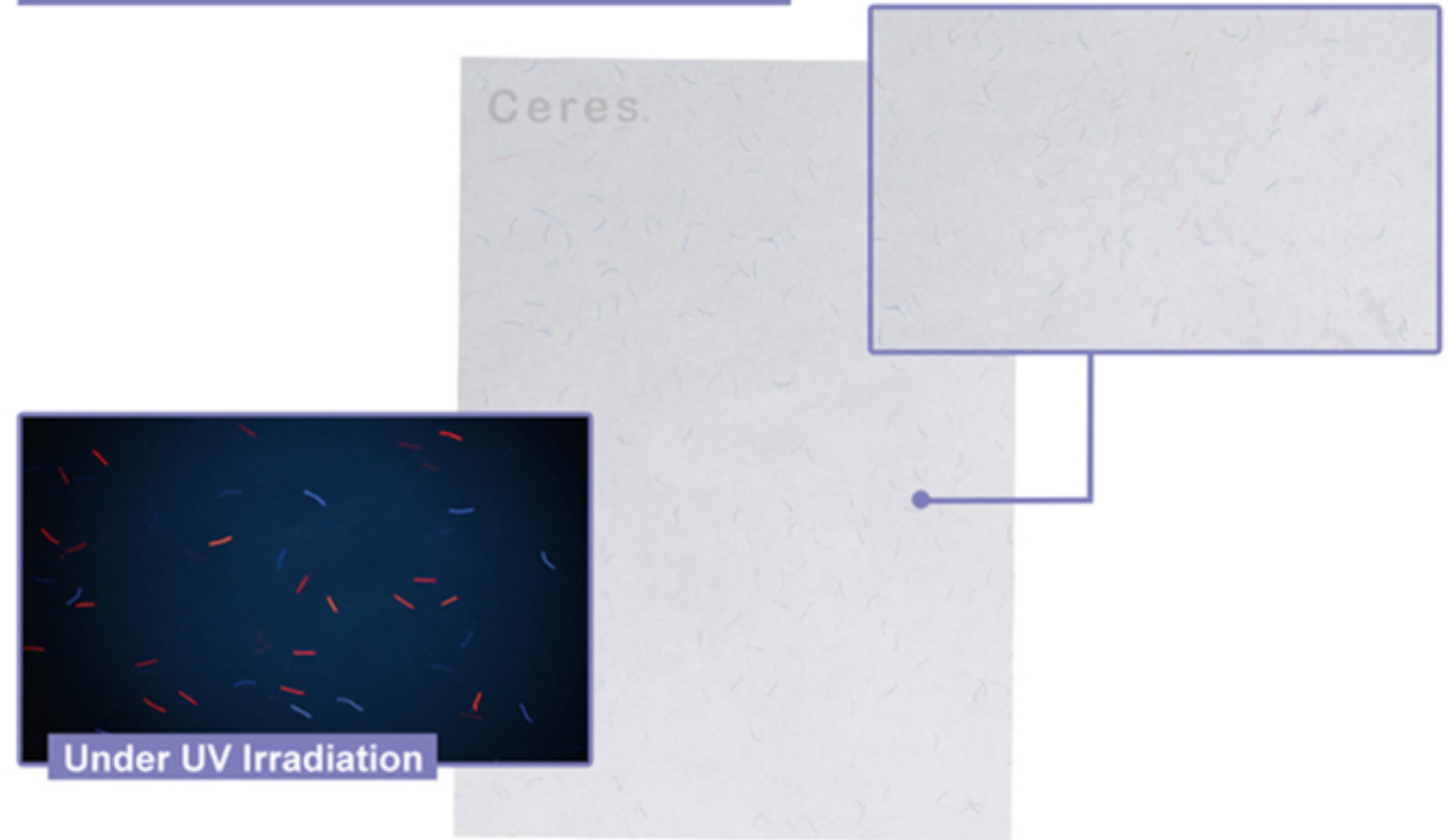

## Safety Thread Paper



## Conductive Fiber Paper

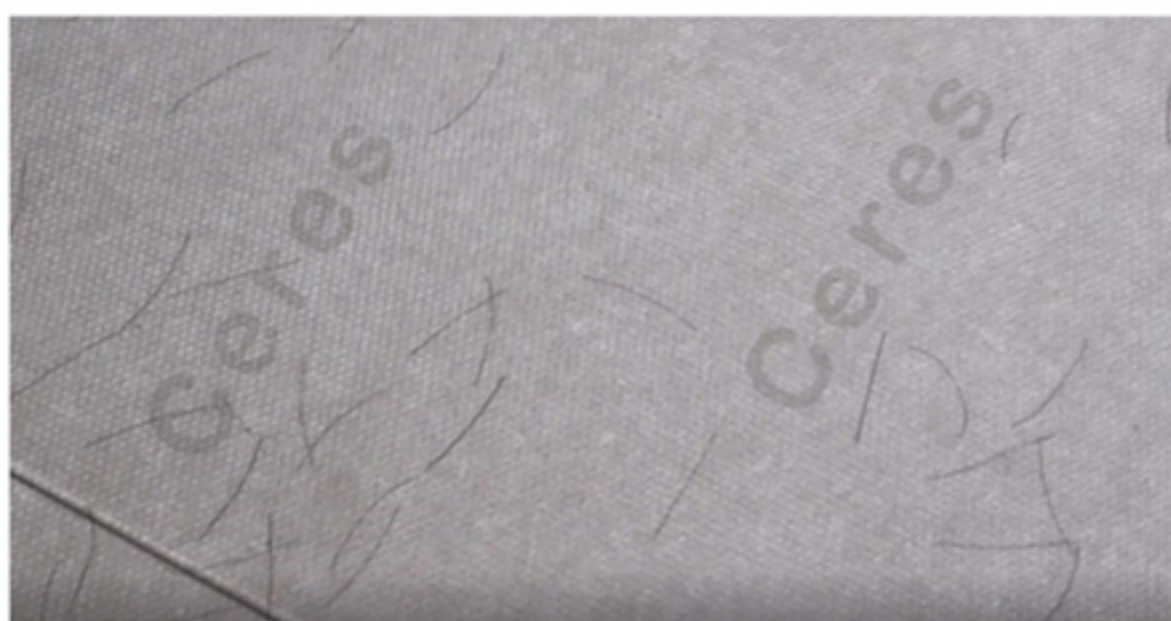



# Screen Printing Ink

## Features

It has good adhesion to substrates, good silk screen printing, bright colors, full imprints, strong adhesion, alcohol resistance, good acid and alkali resistance, good heat resistance and light resistance.



## Application

Suitable for ABS, acrylic plexiglass, KT board, PVC, PC, PS, AS and other plastic injection molding of various transparent plastic sheets.

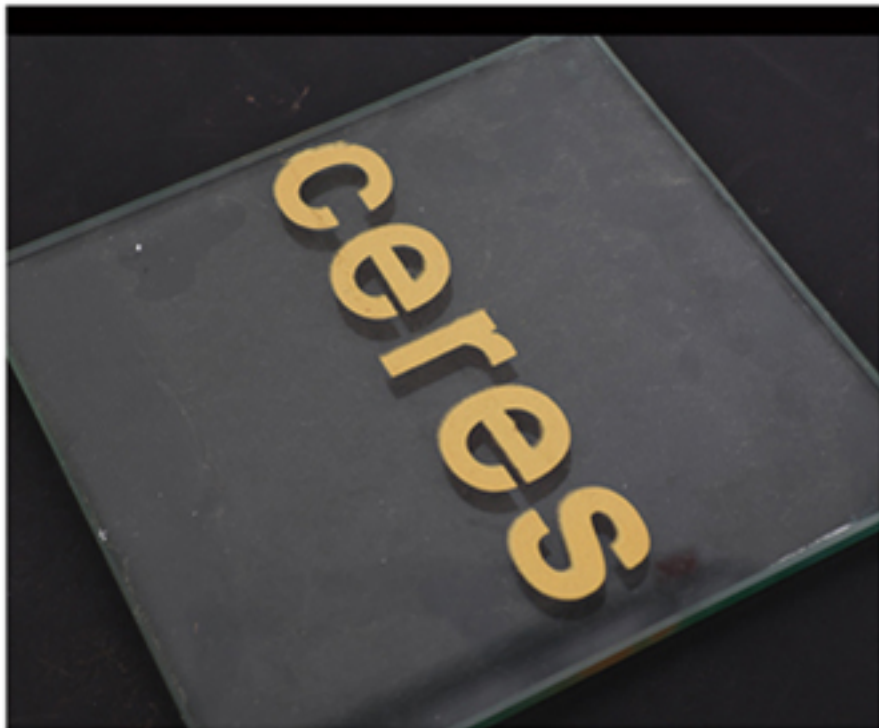

# Fabric Ink

## Technical Features

- ① Odourless
- ② High brightness
- ③ Excellent opacity
- ④ Perfect for flexographic printing
- ⑤ Good continuous printability
- ⑥ Washable after printed





# Metal Decorating Ink

## Features

- Strong adhesion to metal sheets
- Very good solvent resistance
- Very good Light resistance
- Very good Baking resistance
- Very good Cooking resistance



## Application

### Two-piece Cans



Juice



Drink



Beer

### Three-piece Cans



Spray



Snack

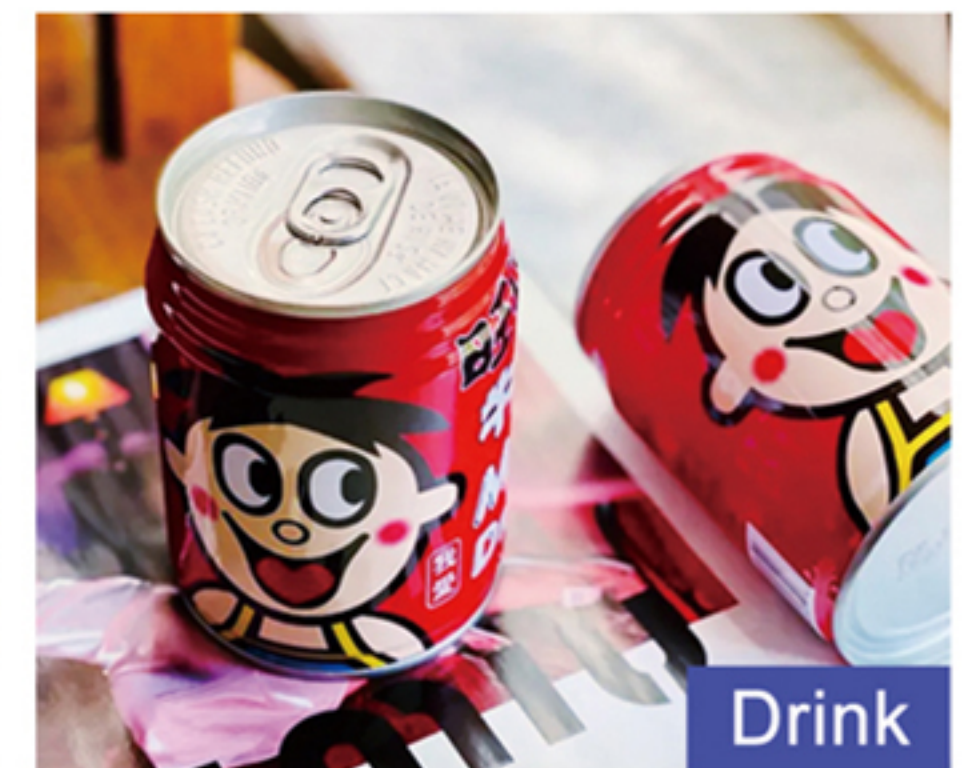

Drink

# Water Base Ink

Application: Suitable for corrugated paper, white cardboard, kraft paper, etc.





## Offset Rubber Blanket (Thickness:0.95mm)



Ceres Blanket YY-355A



Ceres Blanket YY-366A



Ceres Blanket YY-386A

## UV Rubber Blanket

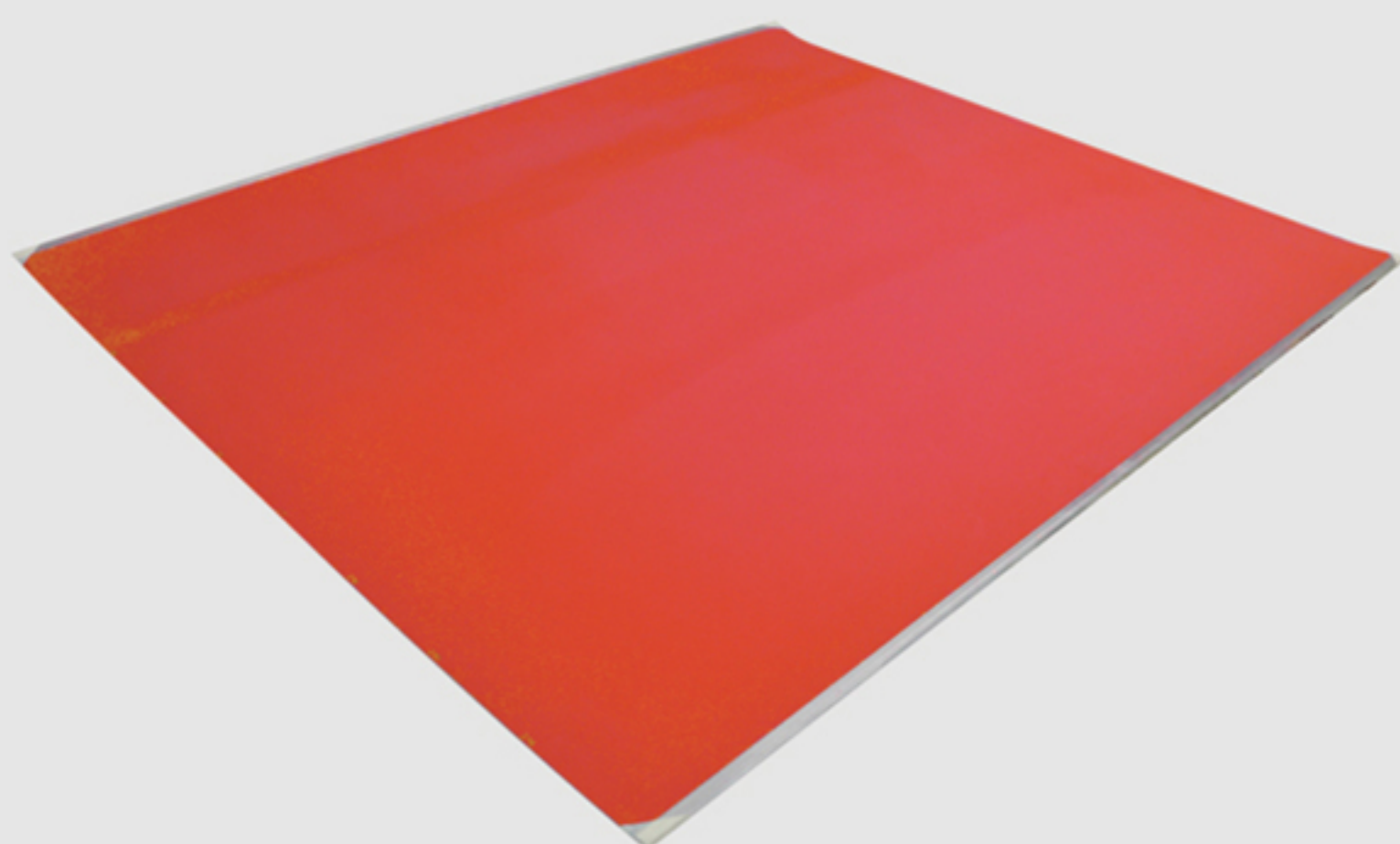

Ceres Blanket YY-362A  
Thickness:0.95mm/1.68mm/1.95mm

## Rotary Rubber Blanket

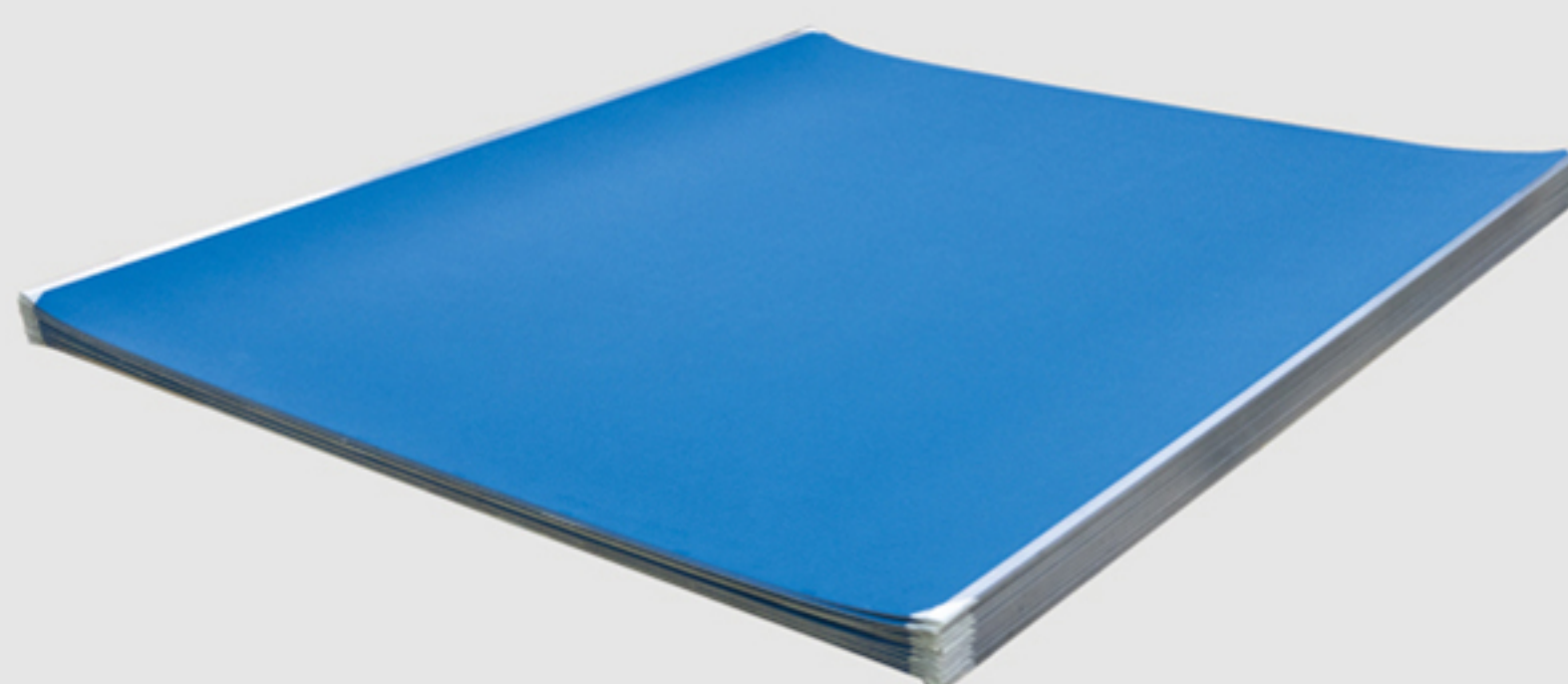

Ceres Blanket YY-386A  
Thickness:1.68mm

## Self-Adhesive Rubber Blanket

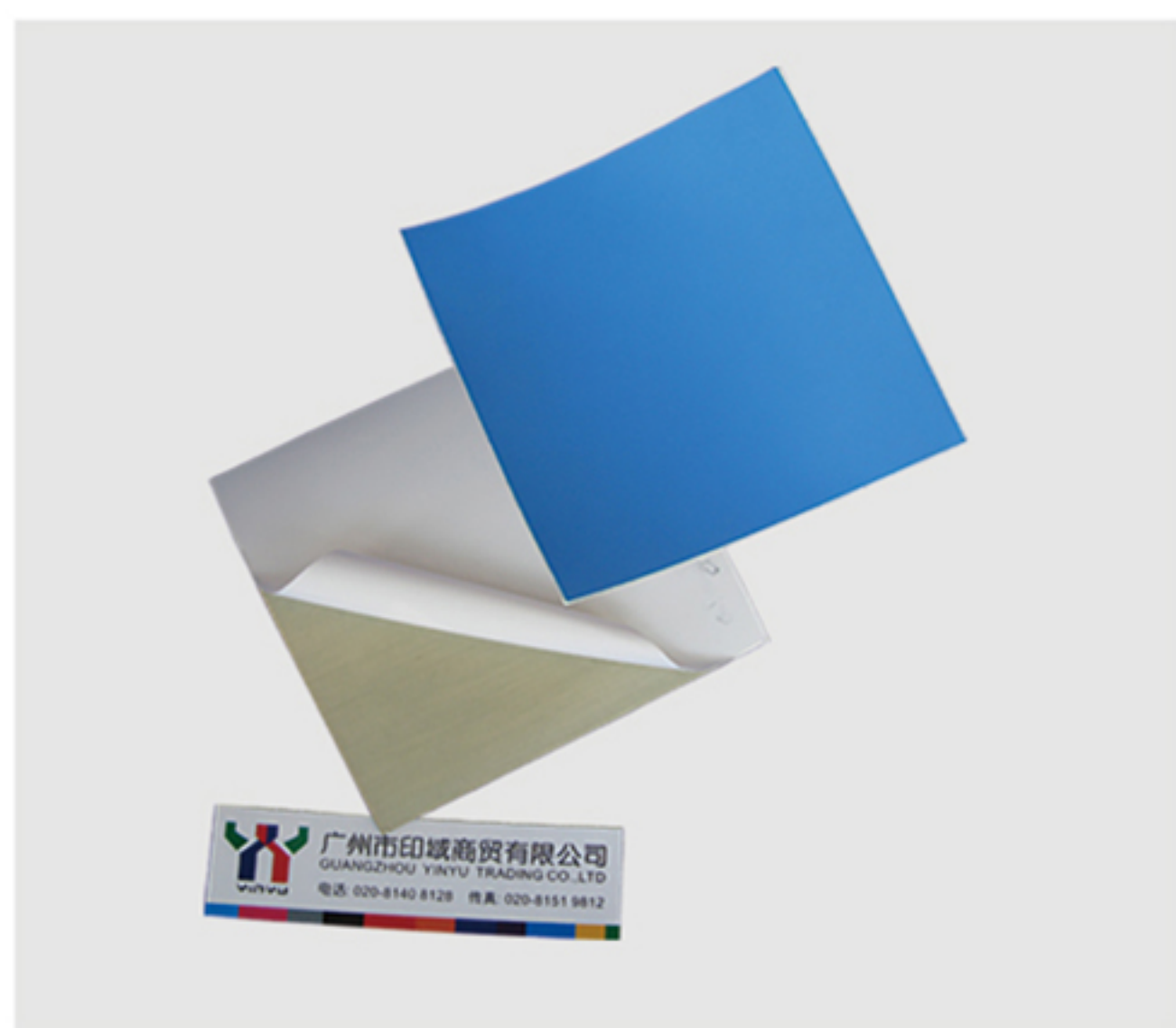

Thickness:0.95mm/1.05mm/1.95mm

## Money Printing Blanket

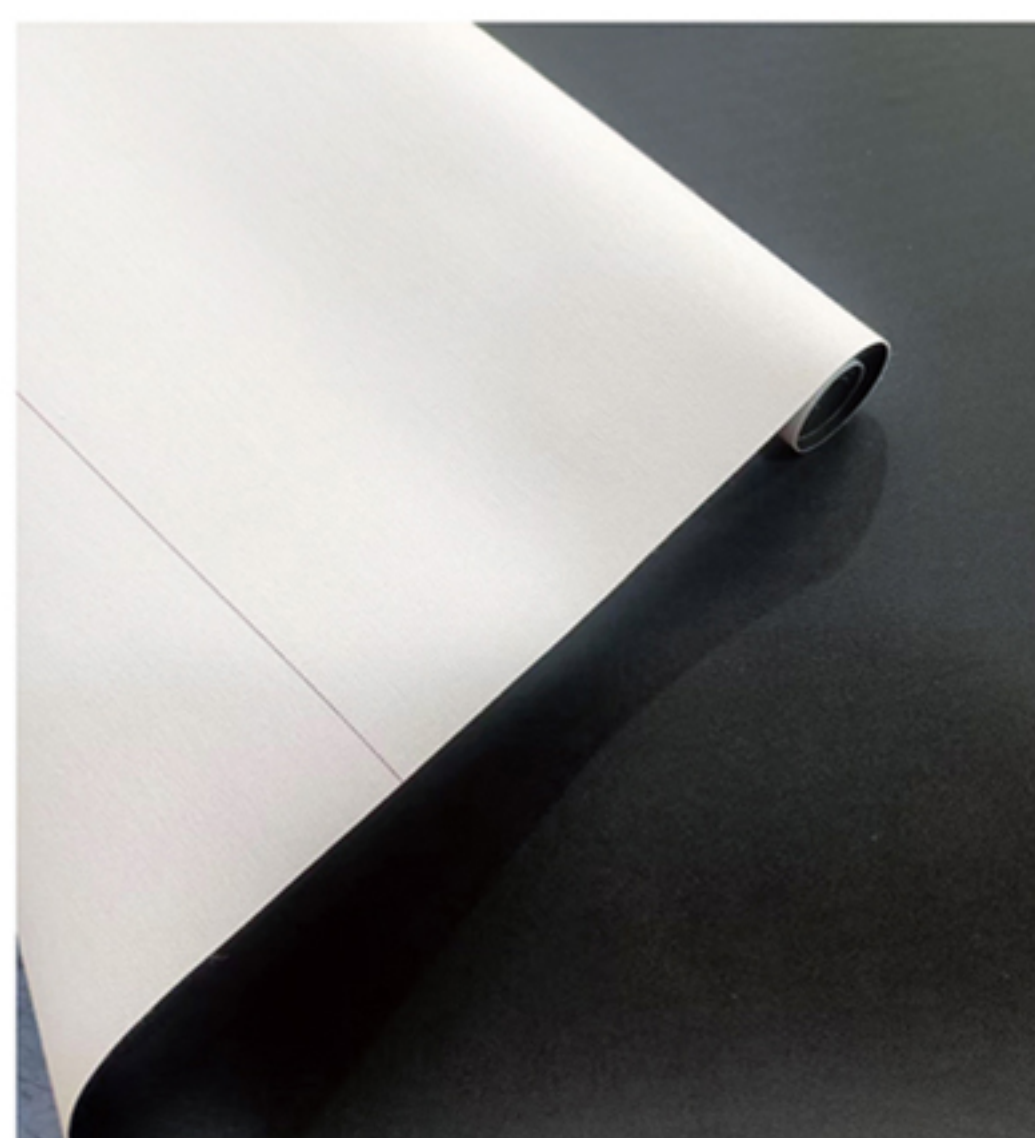

Thickness:0.5mm

## Underpacking Blanket

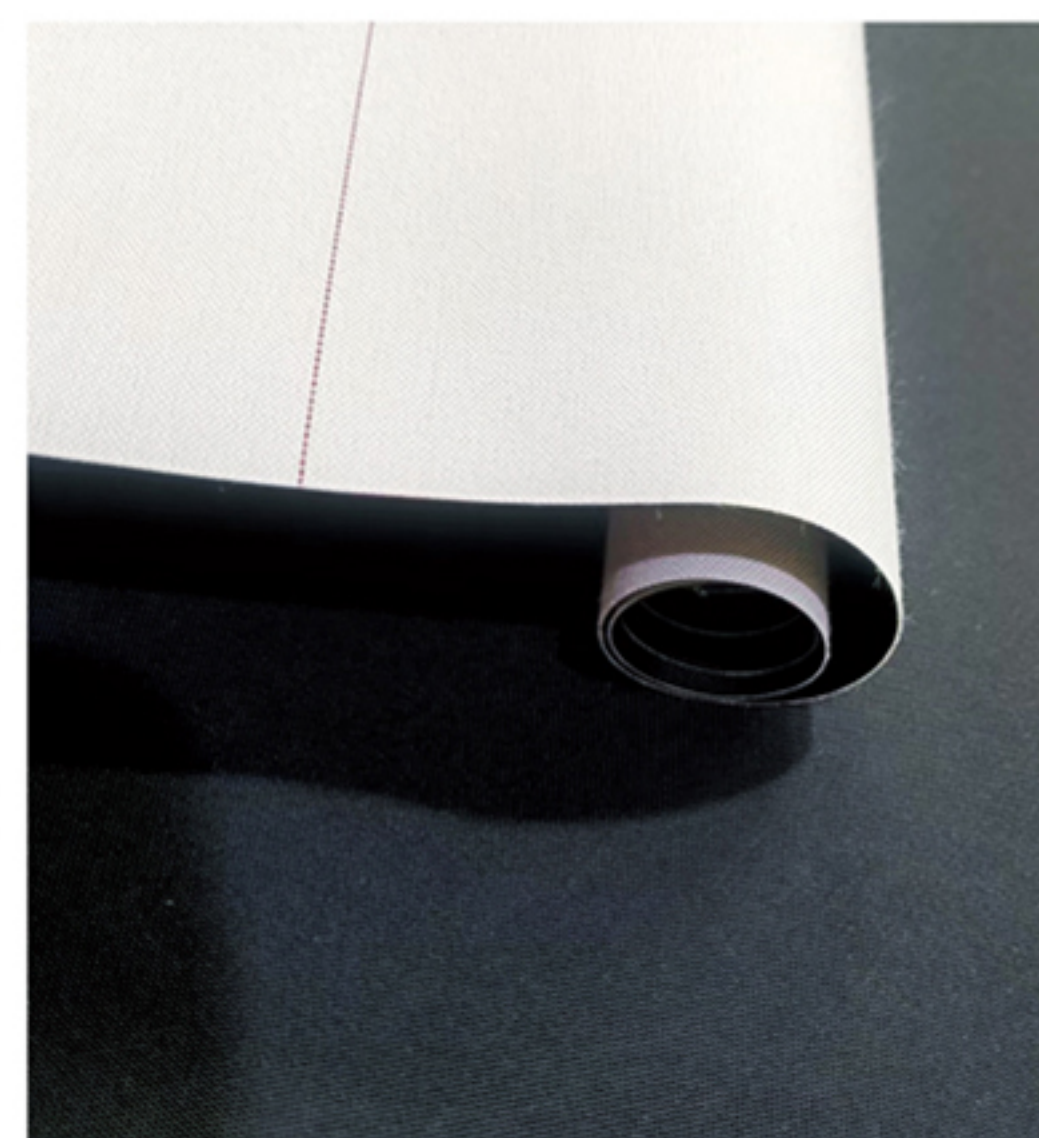

Thickness:0.65mm/1.0mm





# RUBBER BLANKET

Small Thickness Tolerance

Durability

Good dot sharpness

Stable Quality

## BLANKET FACTORY

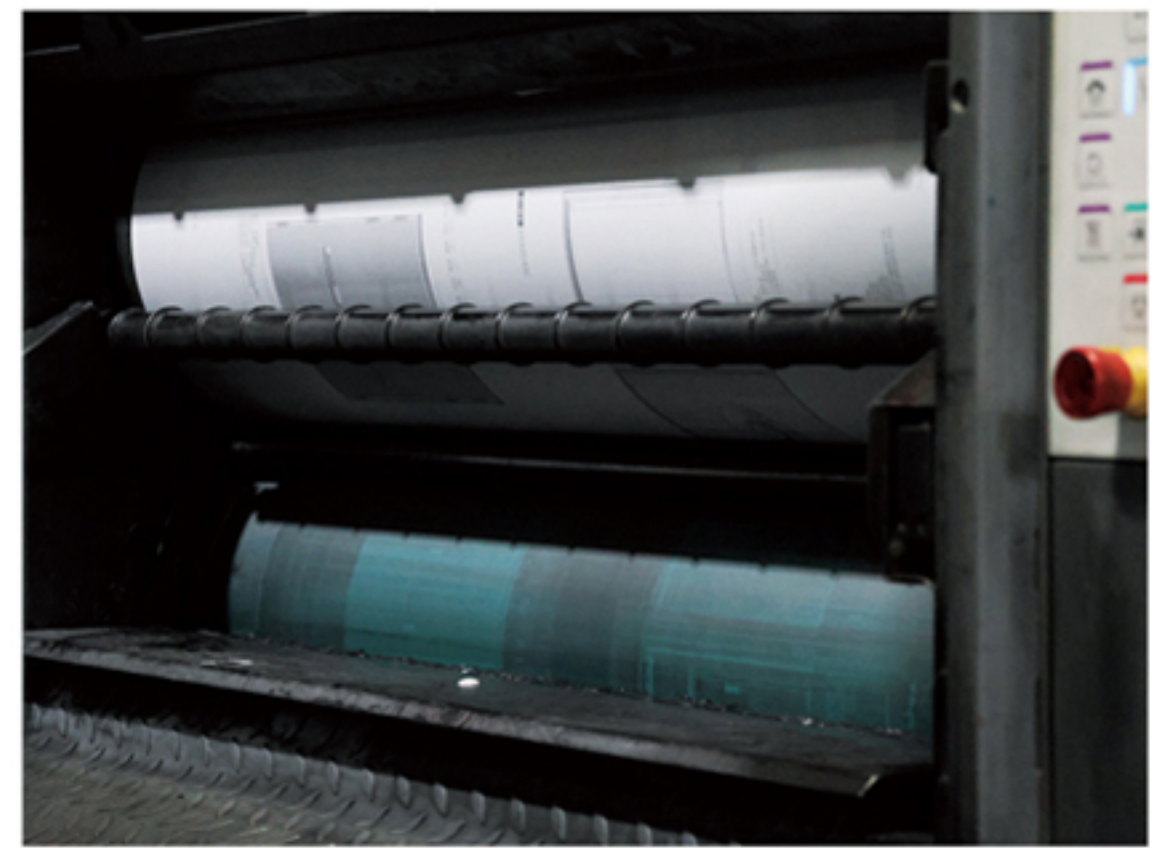
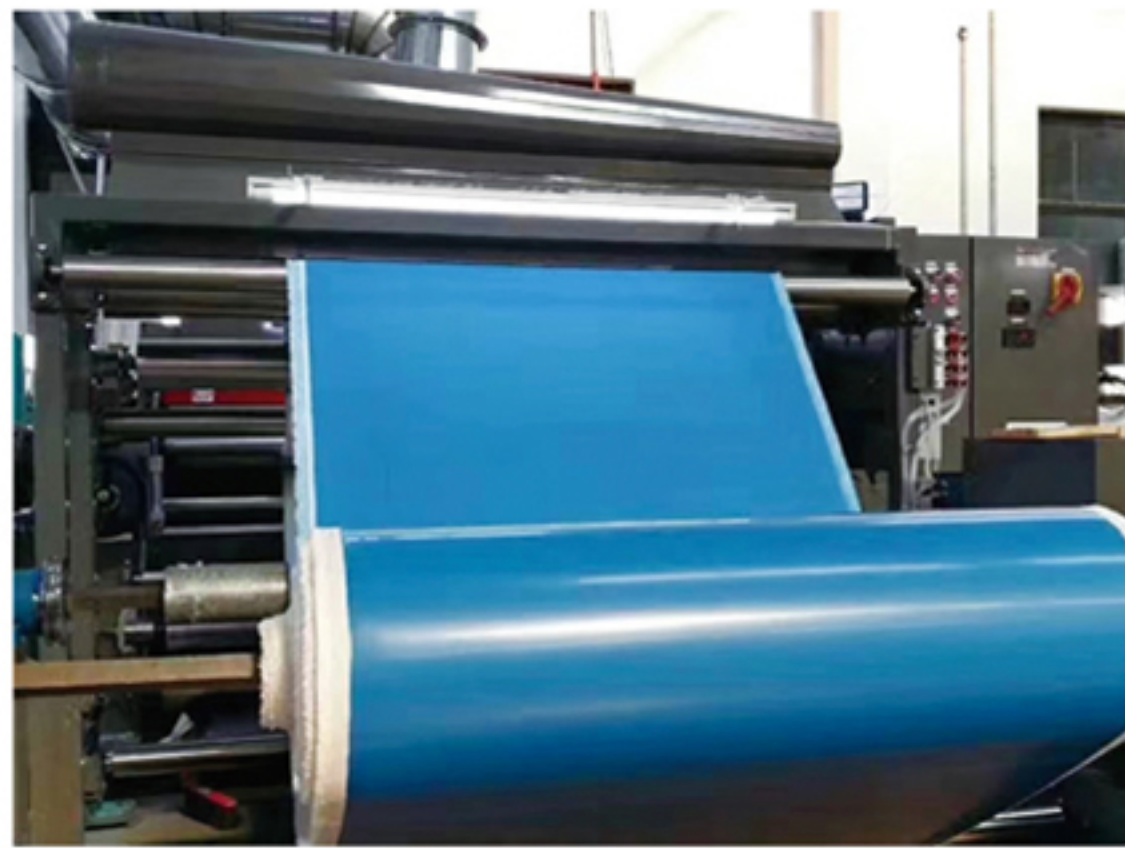
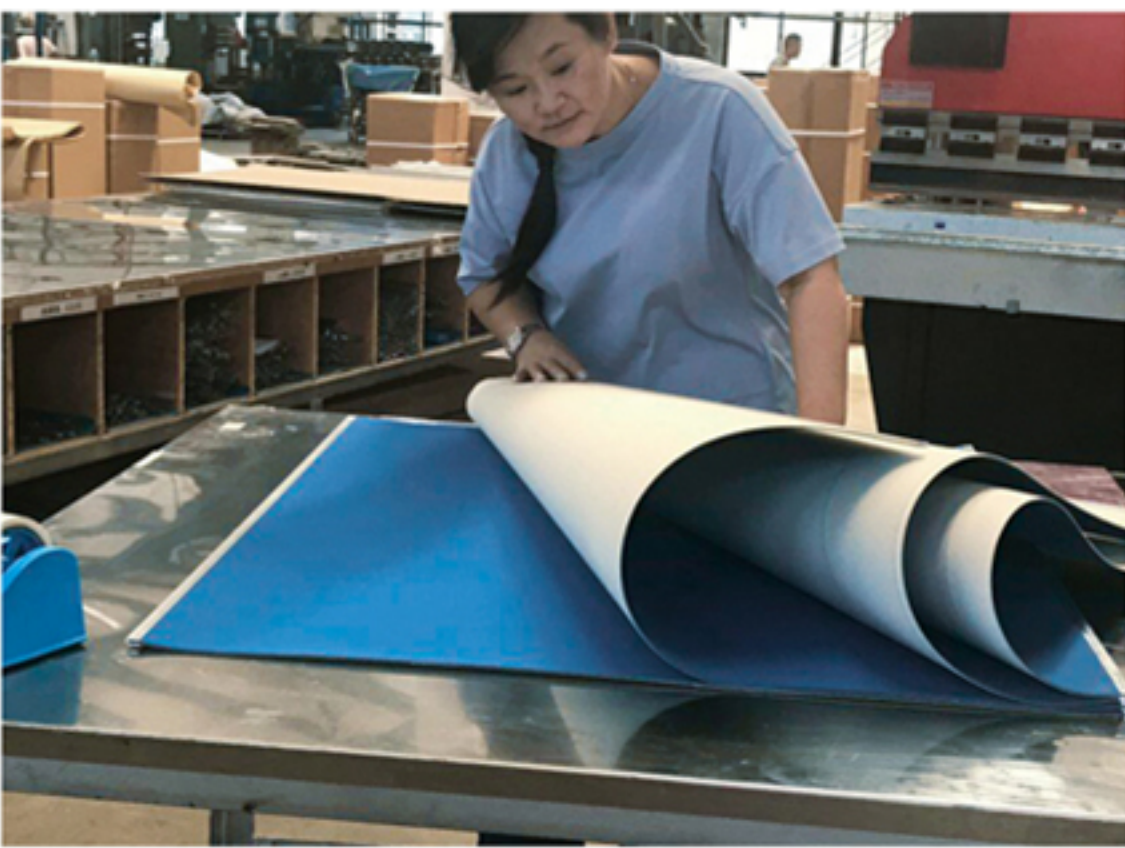

Customize different aluminum bars for different model machine.

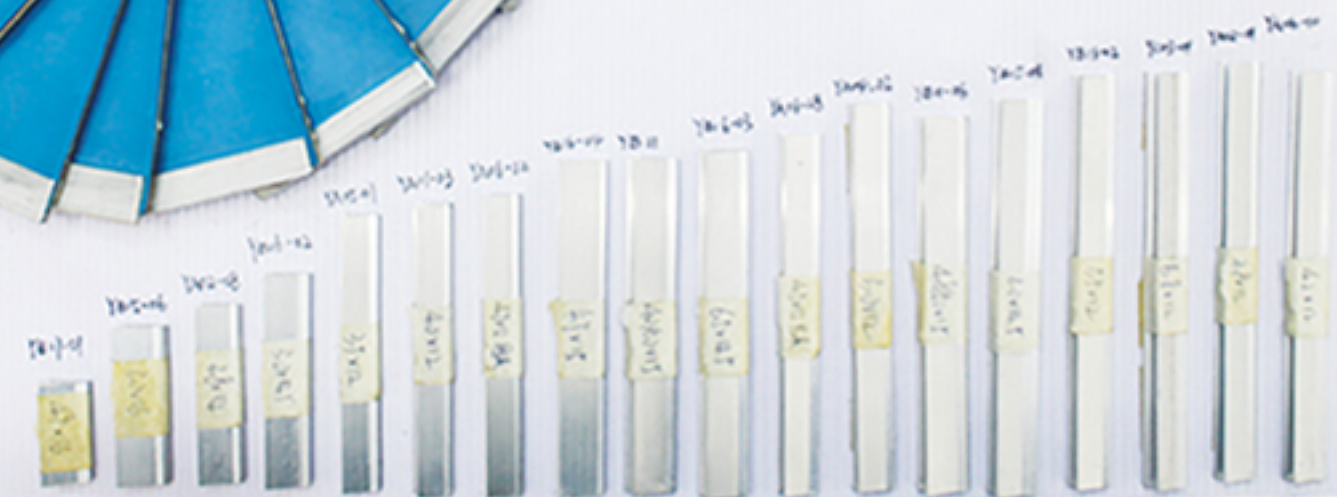

- We could offer you all kinds of printing blankets, such as UV blanket, self-adhesive blanket, high-speed sheet-fed offset blanket, web printing blanket, billprinting blanket.
- Thickness: 0.95mm, 1.68mm, 1.95mm.



# Printing Chemical



YY-363 Plate Cleaner



Blanket Reductant



Super Clean



Anti-Dry



Lube Clean



YY-338 Gum Solution



Fountain Solution



YY-369 Plate Cleaner



Roller Wash



Alcofree Fountain Solution YF-100



Fount Clean



LA 8 Printing Press Chain



Ceres Spray Powder



Water Filter Bag



# Hot Melt Adhesive for Bookbinding

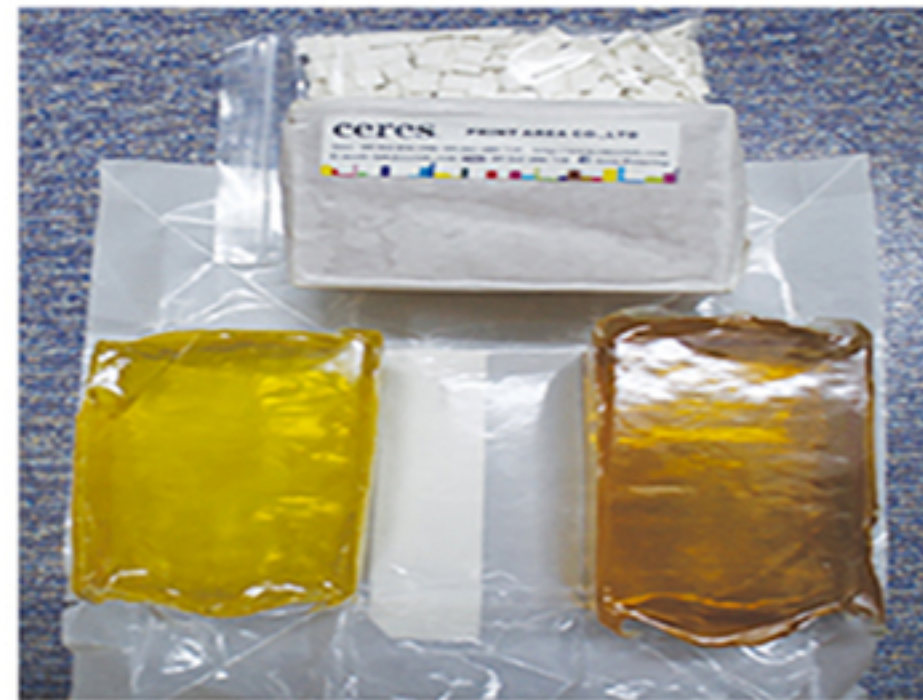





**Ceres PS Plate**

Special specifications can be customized.



**Ceres CTP Plate**

Special specifications can be customized.



Image Remover / KOYO Retouch Pen



Germany Viscovita Sponge

**ARFA HUN Film**

**ARFA HS Film**

**Specification**

- Membrane: Outer/Inner
- Diameter: 50.8mm-71.9mm
- Flange: Hard/Soft
- The highest density is 5.0: the exposure and rinsing latitude is large, the resolution is high, and the dots and lines are clear and sharp.
- High contrast, red light, suitable for image recording of krypton laser sources.



UGRA / Fujifilm Gray Scale



TOYOBO Printight Photo-sensitive Nylon Printing Plate A1/A2/A3



Germany Lohmann Double Side Tape



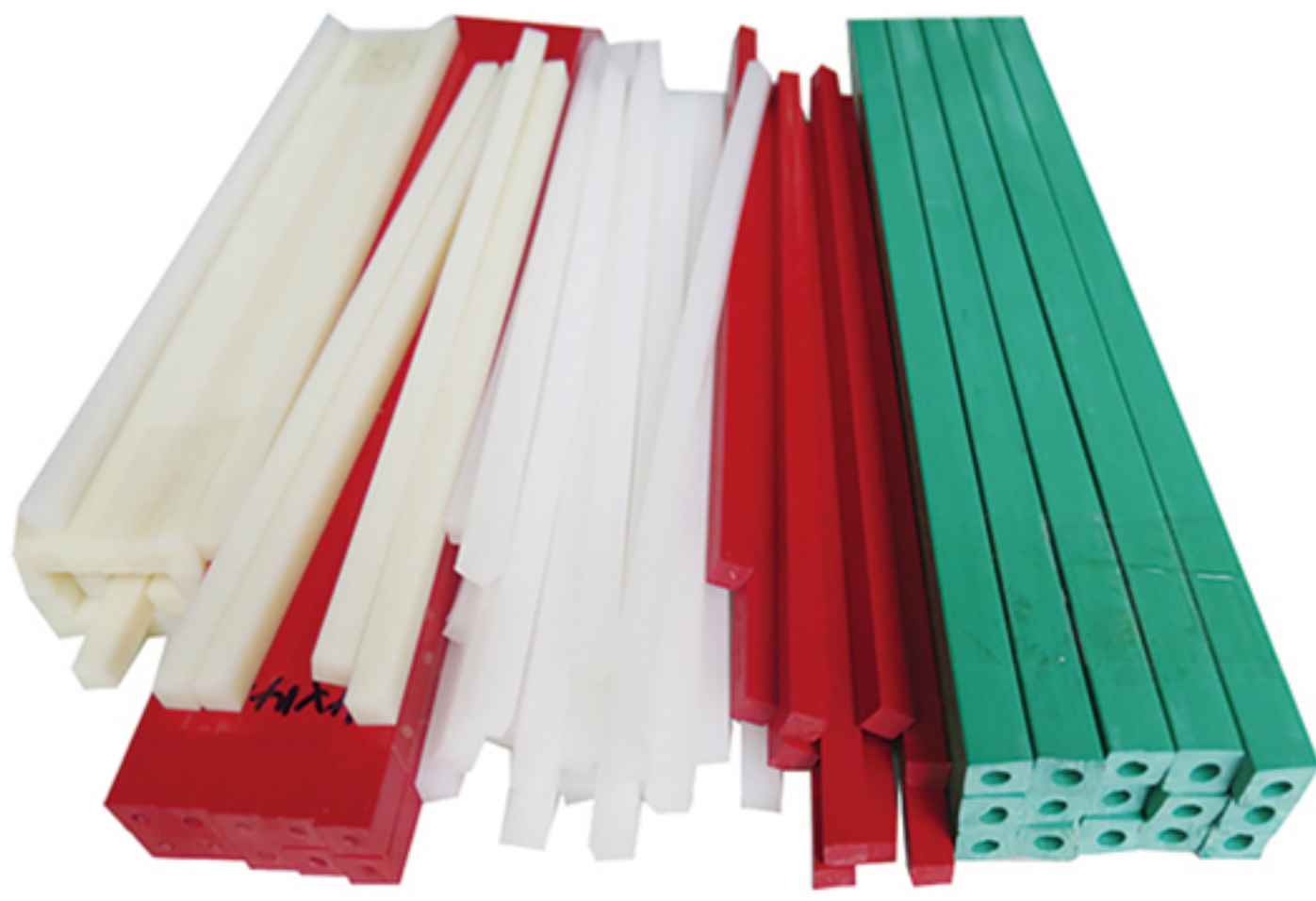

Cutting Sticks(PE/PVC/NYLON)  
All the sizes could be customized.



Polar Cutting Sticks  
(For different sizes)



Weight	Thickness	Height					
		23.5	23.4	23.3	23.2	23.1	23
200	0.28mm	0.3*1.0	0.4*1.0				
250	0.35mm	0.3*1.2	0.4*1.2	0.5*1.2			
300	0.42mm	0.3*1.3	0.4*1.3	0.5*1.4			
350	0.50mm		0.4*1.4	0.5*1.5	0.6*1.5		
400	0.56mm			0.5*1.6	0.6*1.6		
450	0.63mm			0.5*1.7	0.6*1.7	0.7*1.7	
500	0.70mm					0.7*1.7	0.8*1.7

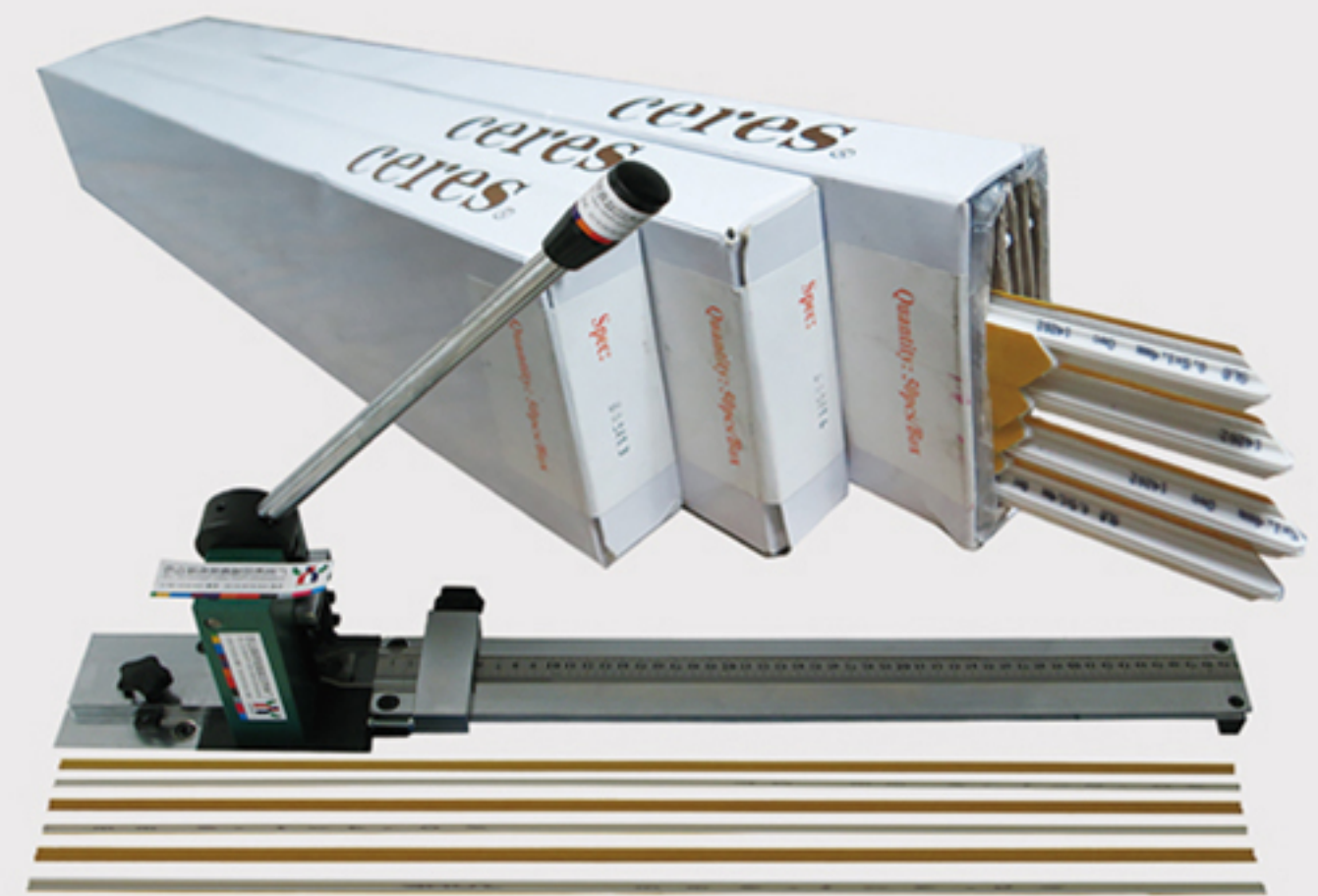

Ceres Creasing Matrix



Perfect Perf

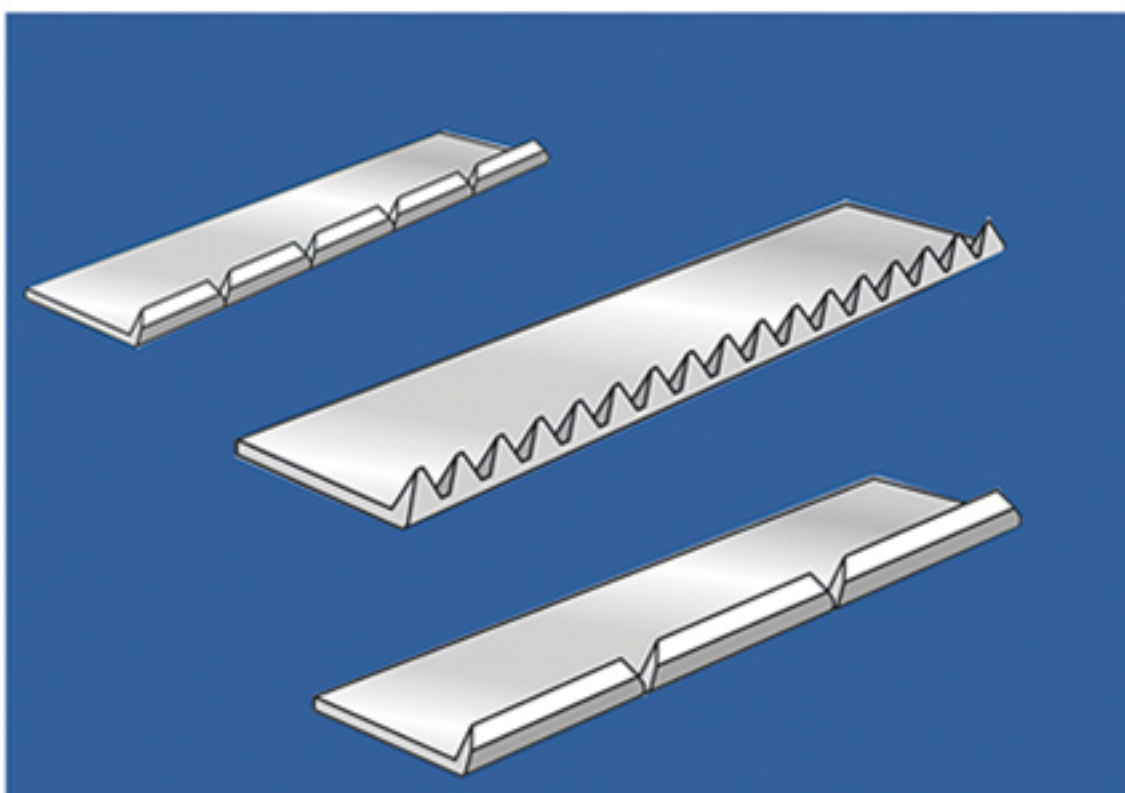
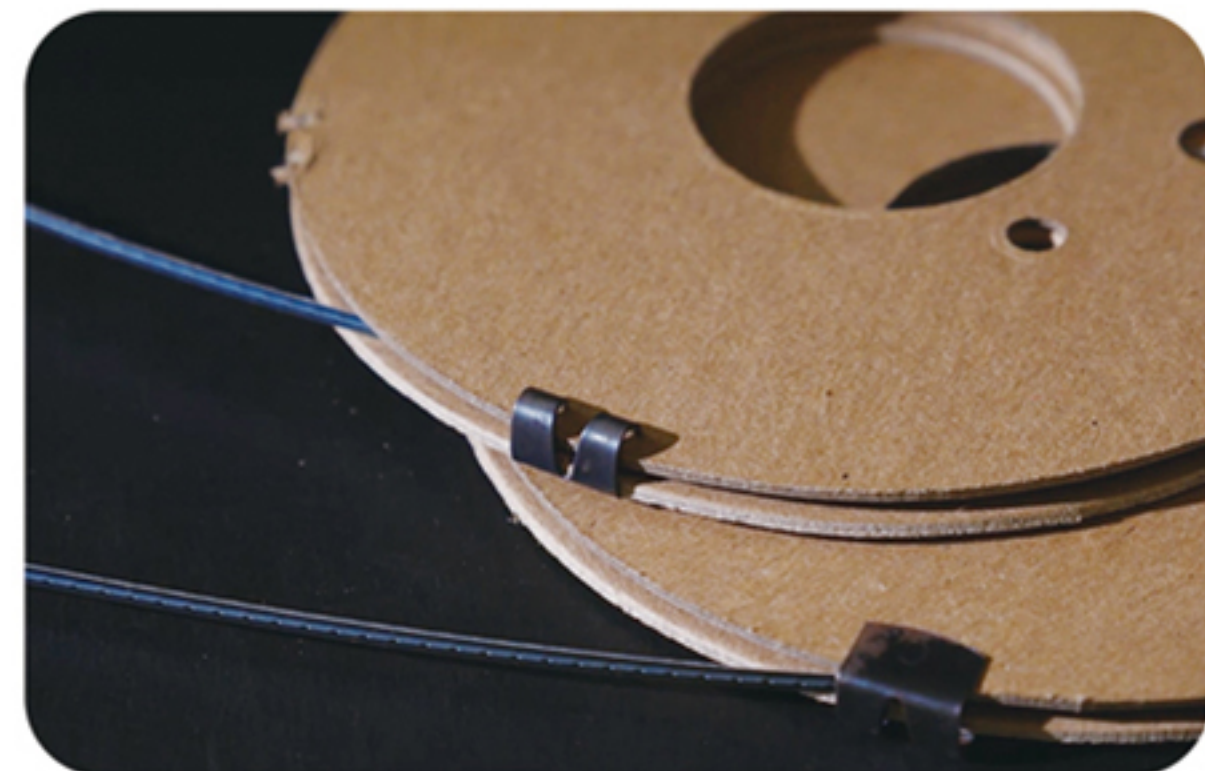
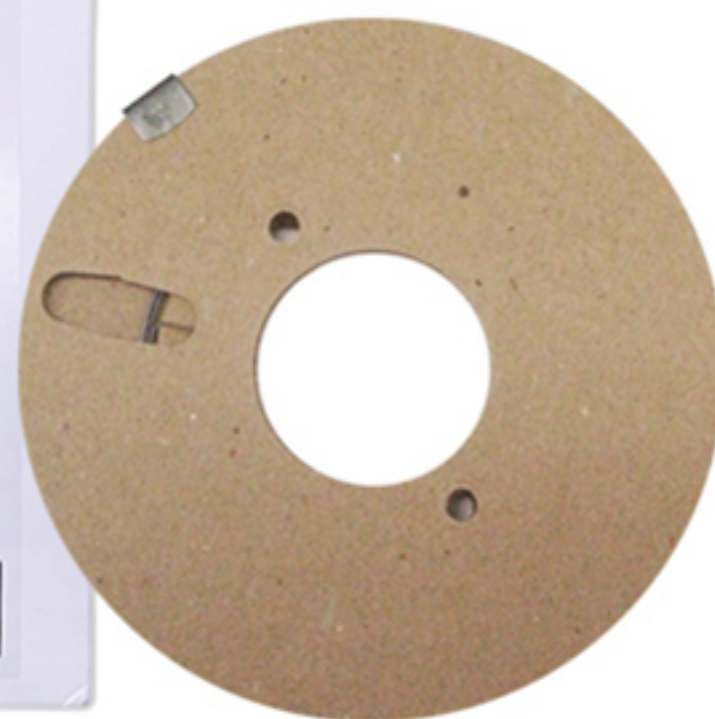

PERF		16 TPI		12 TPI		8 TPI		6 TPI	
Description	Item #	Description	Item #	Description	Item #	Description	Item #	Description	Item #
Card 10 ft (3 m)	T-504	Card 10 ft (3 m)	T-506	Card 10 ft (3 m)	T-508	Card 10 ft (3 m)	T-510	Card 10 ft (3 m)	T-511
Card 20 ft (6 m)	T-505	Card 20 ft (6 m)	T-507	Card 20 ft (6 m)	T-509	Card 20 ft (6 m)	T-511	Card 20 ft (6 m)	T-511
Paper 10 ft (3 m)	T-604	Paper 10 ft (3 m)	T-606	Paper 10 ft (3 m)	T-608	Paper 10 ft (3 m)	T-610	Paper 10 ft (3 m)	T-611
Paper 20 ft (6 m)	T-605	Paper 20 ft (6 m)	T-607	Paper 20 ft (6 m)	T-609	Paper 20 ft (6 m)	T-611	Paper 20 ft (6 m)	T-611

MICRO-PERF		30 TPI		40 TPI		50 TPI	
Description	Item #	Description	Item #	Description	Item #	Description	Item #
Paper 10 ft (3 m)	T-619	Paper 10 ft (3 m)	T-620	Paper 10 ft (3 m)	T-621		
Paper 20 ft (6 m)	T-616	Paper 20 ft (6 m)	T-617	Paper 20 ft (6 m)	T-618		

SNAP		4 TPI		3 TPI	
Description	Item #	Description	Item #	Description	Item #
Card 10 ft (3 m)	T-512	Card 10 ft (3 m)	T-514	Card 10 ft (3 m)	T-515
Card 20 ft (6 m)	T-513	Card 20 ft (6 m)	T-515	Card 20 ft (6 m)	T-515
Paper 10 ft (3 m)	T-612	Paper 10 ft (3 m)	T-614	Paper 10 ft (3 m)	T-614
Paper 20 ft (6 m)	T-613	Paper 20 ft (6 m)	T-615	Paper 20 ft (6 m)	T-615

SLIT		SCORE	
Description	Item #	Description	Item #
Card 10 ft (3 m)	T-502	Card 10 ft (3 m)	T-500
Card 20 ft (6 m)	T-503	Card 20 ft (6 m)	T-501
Paper 10 ft (3 m)	T-602	Card (round top) 20 ft (6 m)	T-501-R
Paper 20 ft (6 m)	T-603	Paper 10 ft (3 m)	T-600
		Paper 20 ft (6 m)	T-601



## Printing Spare Part



Delivery Belt



Cutter Dust Belt



Paste Box  
Machine Belt



Slow Down Belt



Timing Belt



Dusting Machine  
Belt



Belt



Delivery Belt



Heidelberg SM74  
Slow Down Belt



Heidelberg SM74  
Vacuum Feed Belt



Slow Down Belt



Synchronize Belt

## Printing Machine Belt Cutter Dust Belt

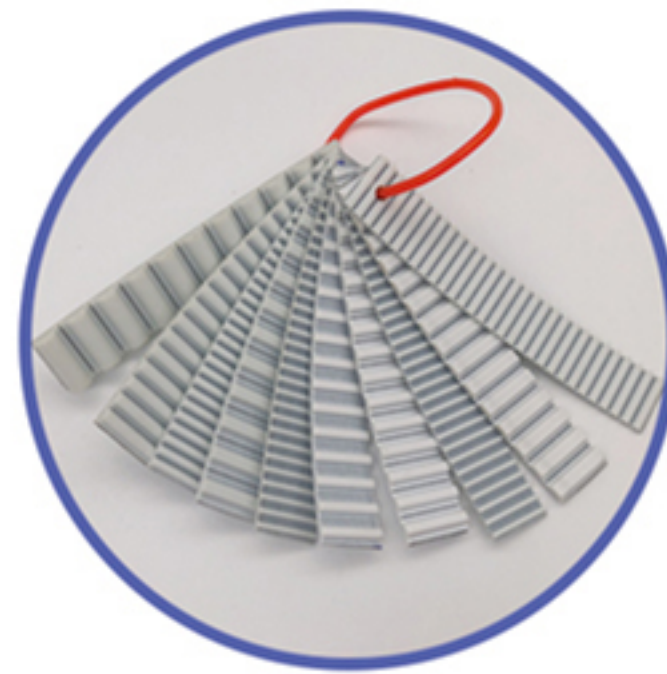
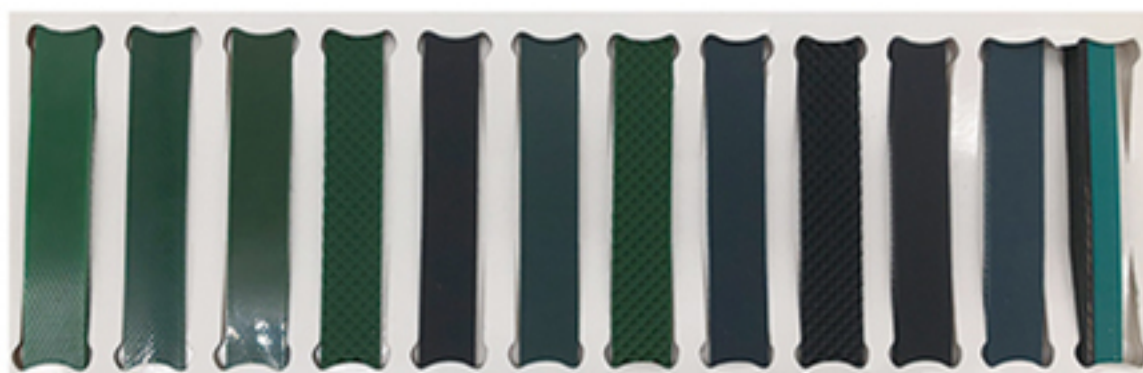

## Numbering Machine

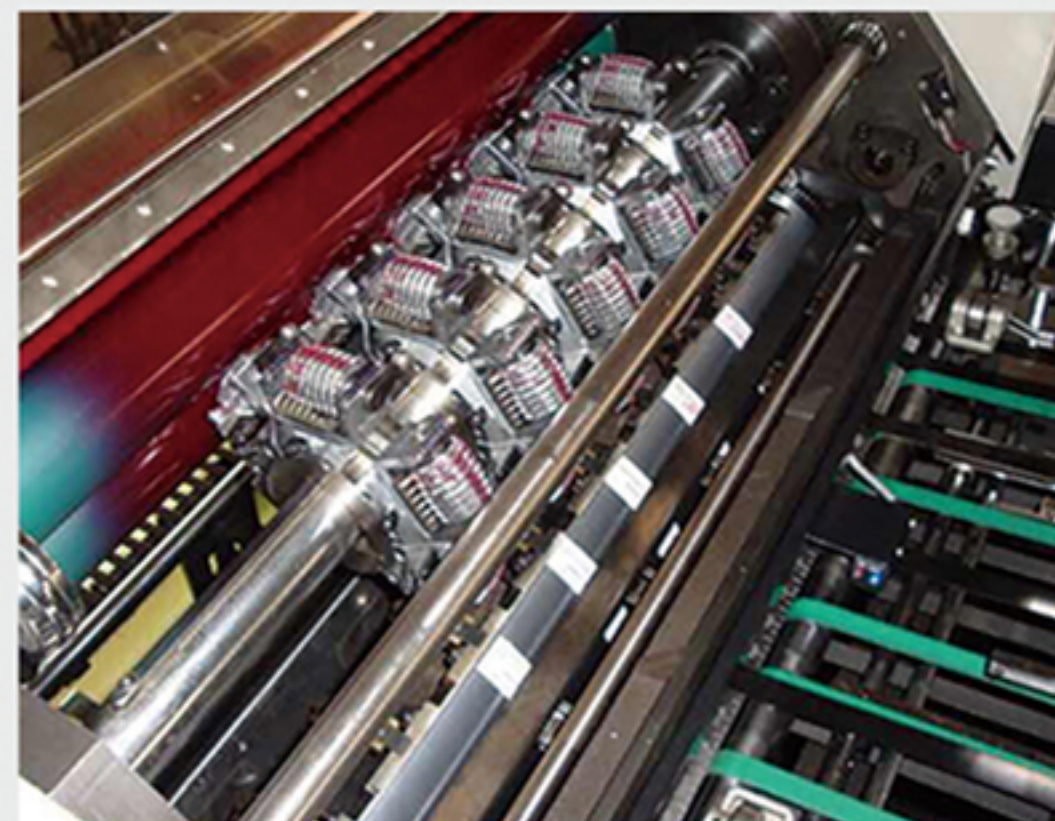
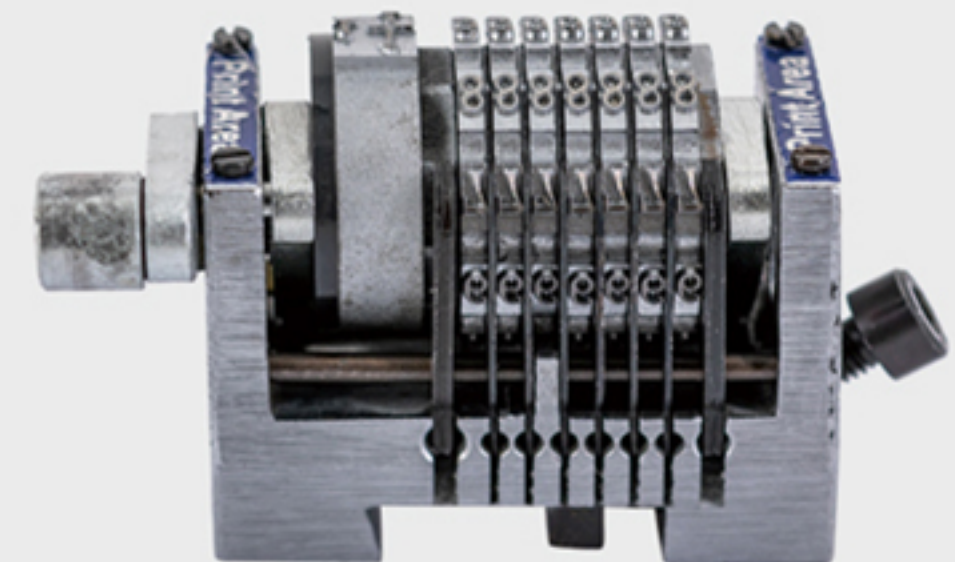
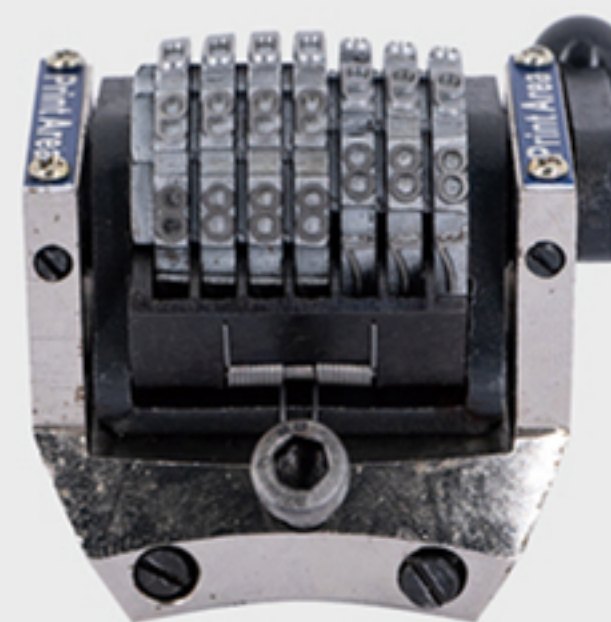
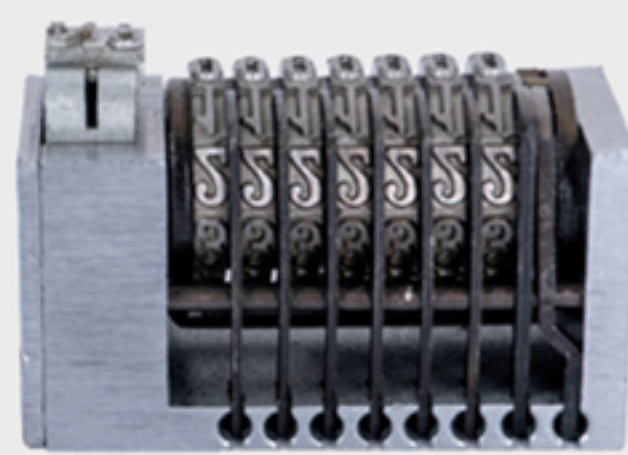
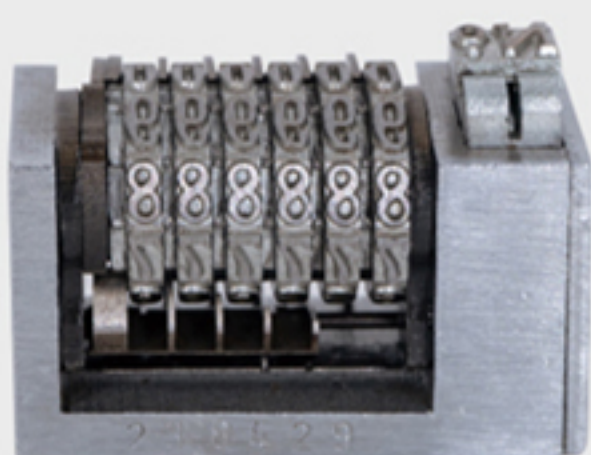

Special specifications can be customized(Font/Size/Number of digits)



## Ink Roller

All Heidelberg, Komori, Roland, Mitsubishi, Ryobi, Akiyama etc could be customized.



## Gripper Bar

All Heidelberg, Komori, Roland, Mitsubishi, Ryobi, Akiyama etc could be customized.

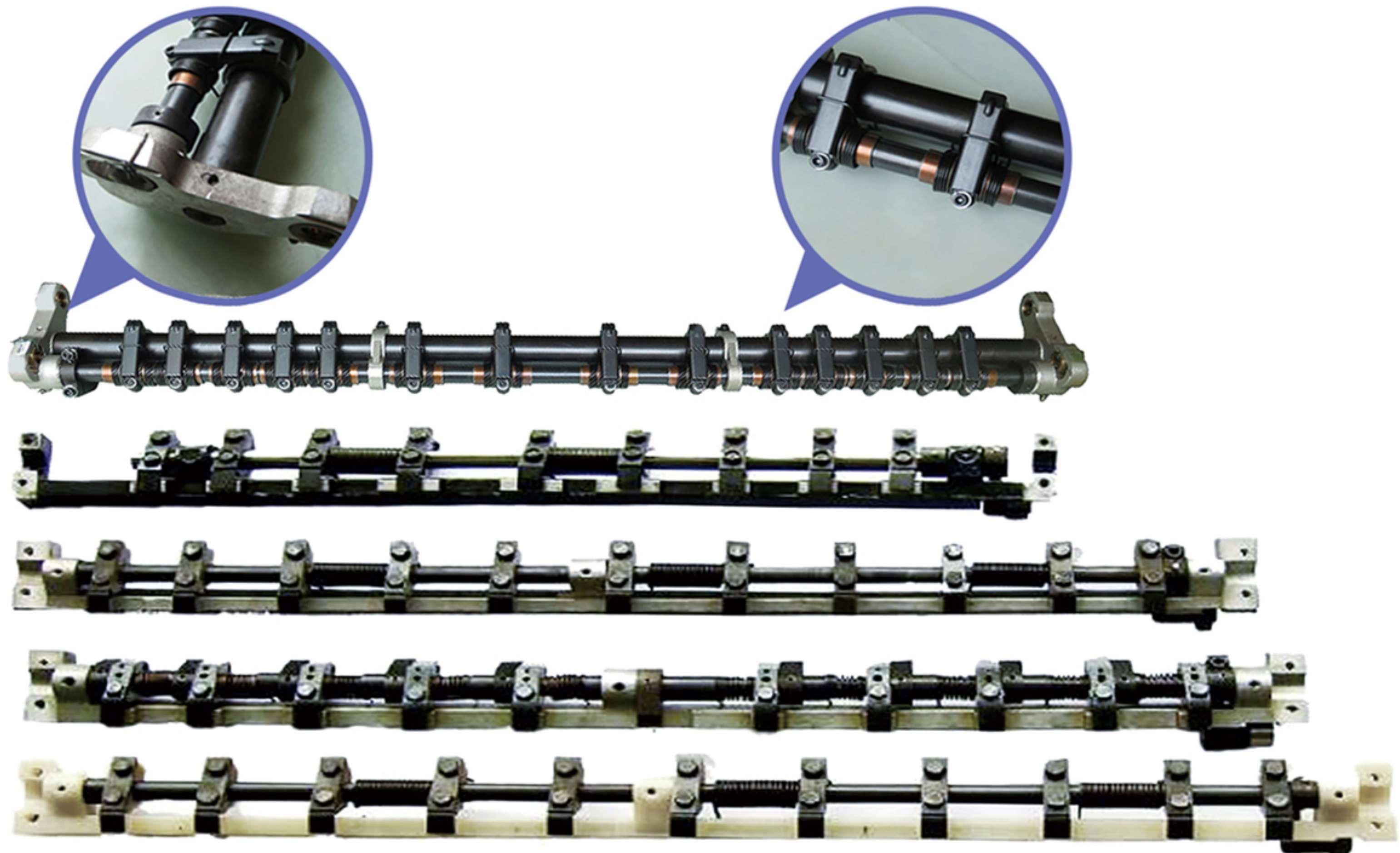



## Brush Wheel (All the sizes can be customized.)

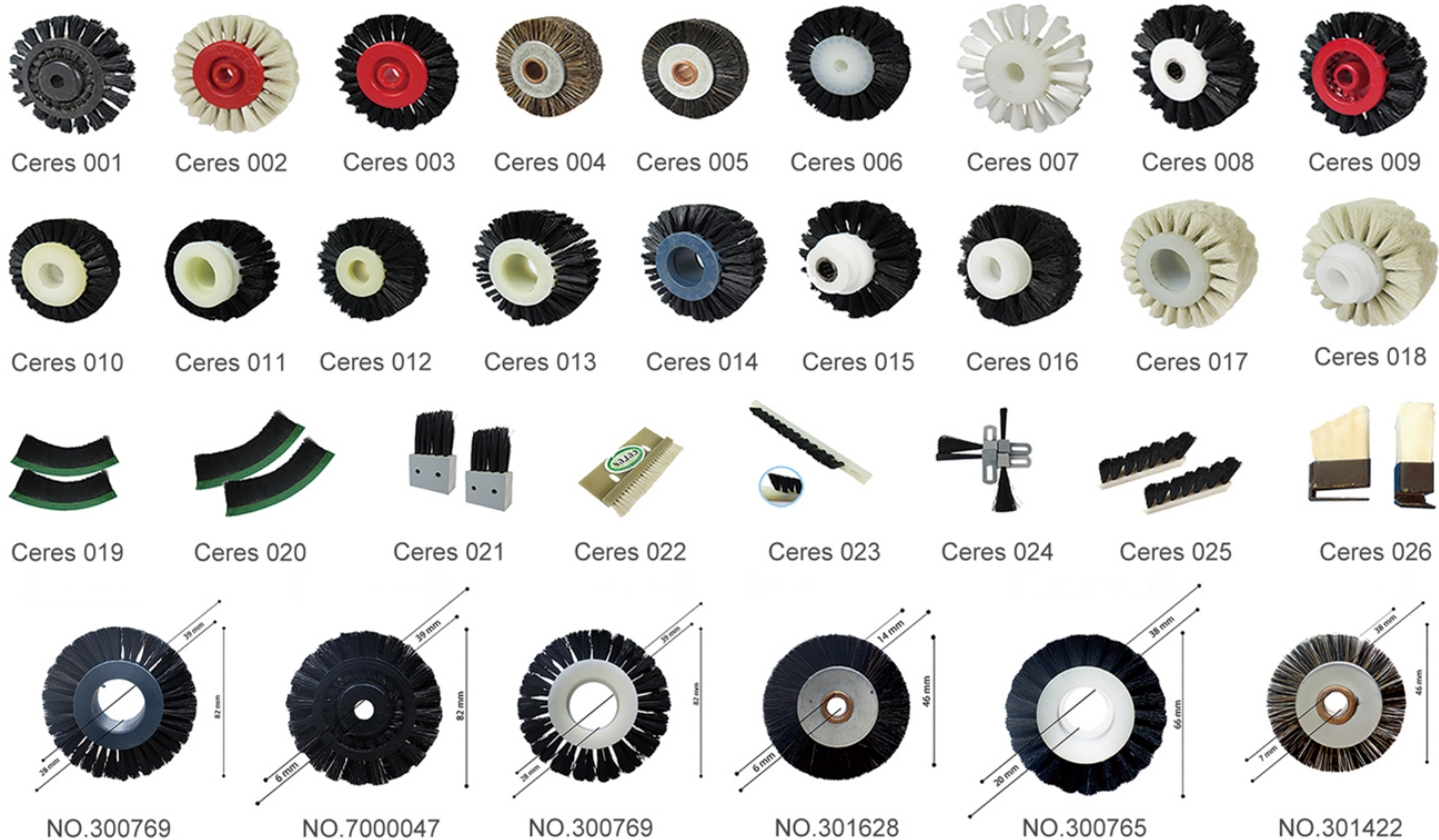

## Printing Rubber Sucker (All the sizes can be customized.)





## Impression Cylinder Jacket

All Heidelberg, Komori, Roland, Mitsubishi, Ryobi, Akiyama etc could be customized.

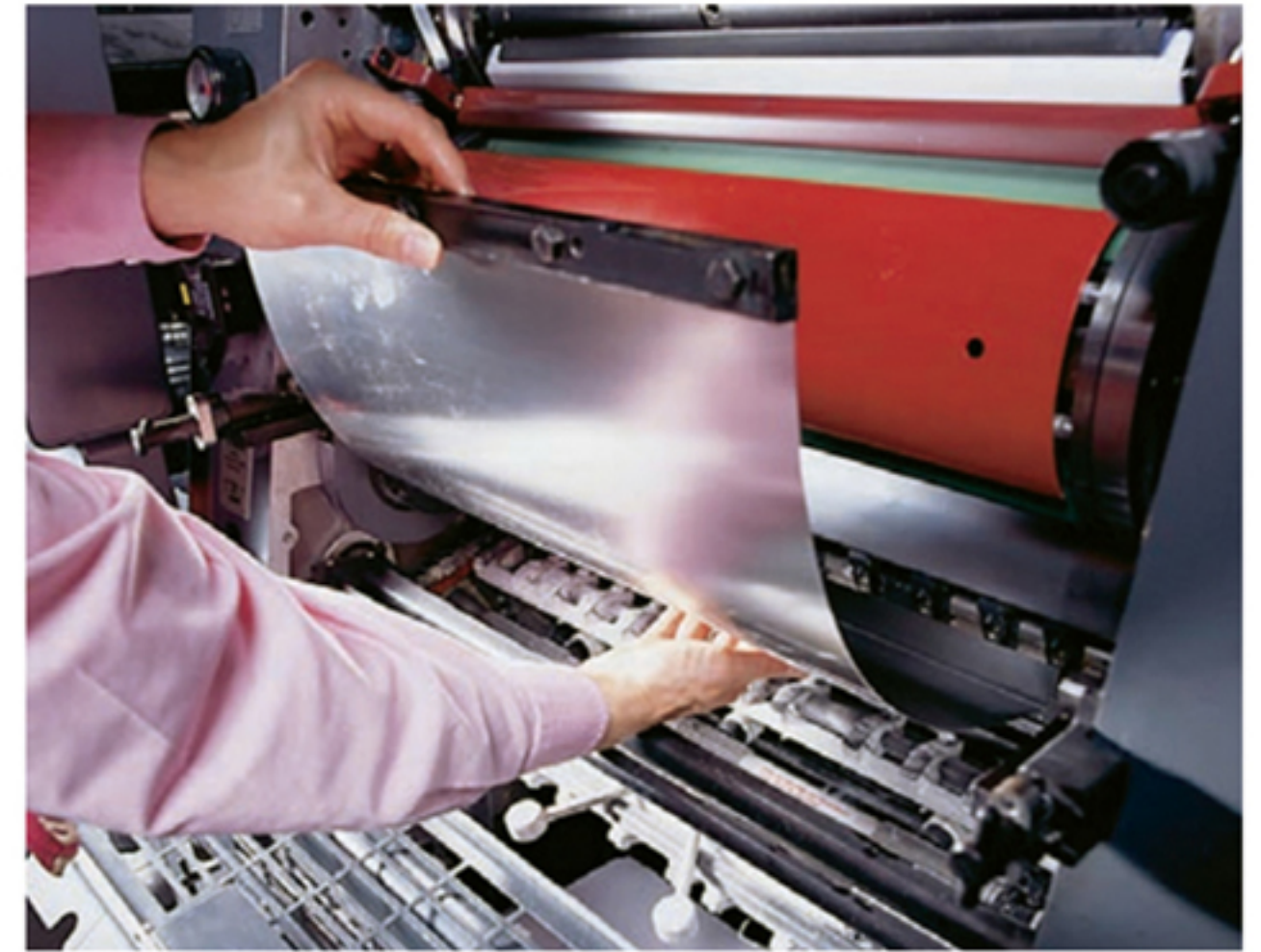

## Wash Up Blades

All Heidelberg, Komori, Roland, Mitsubishi, Ryobi, Akiyama etc could be customized.

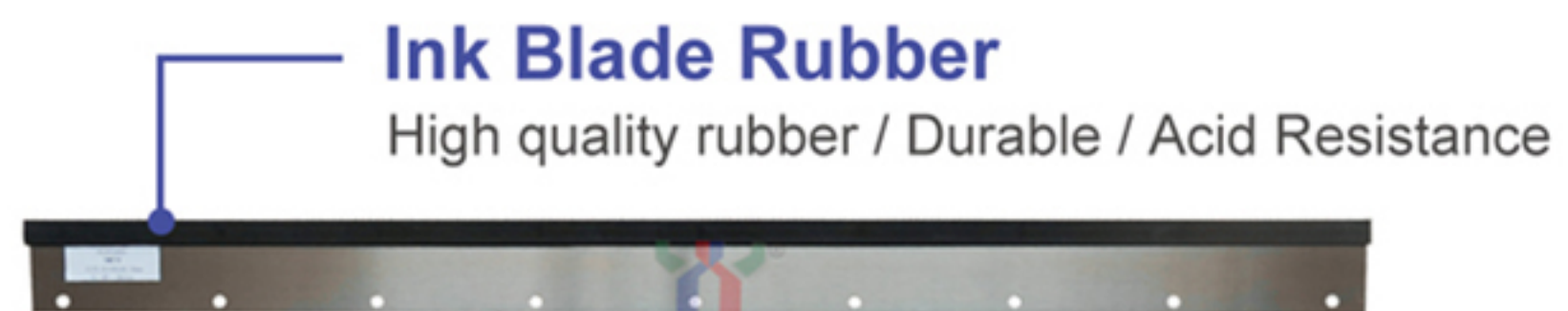

### Ink Blade Rubber

High quality rubber / Durable / Acid Resistance



### Ink Blade

The position between holes is precise, convenient installation.





**Printing Spare Part**



Four color ink knife



Steel ink knife



Nylon ink knife



Ink duct end block



Paper modulator



Martini muller



Red corner block



Pig tail wrench



Ink hickey picker

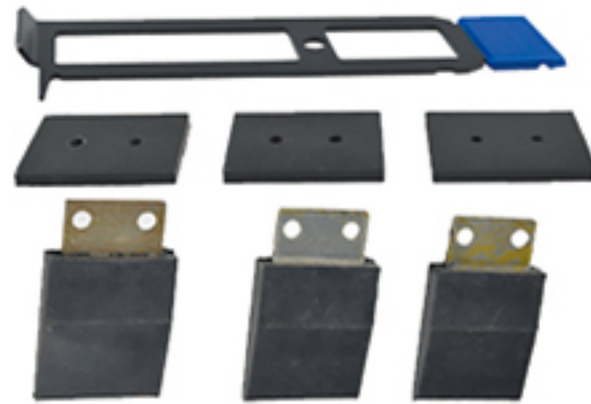

Komori shovel



Dragon book blinding machine shifter lever



Komori paper wedge



Guide strap GTO46/Kord



Cam Follower



Gripper



Ink Motor



Paper Drill Bit



Kord 46 Gripper Pad



GTO 46 Gripper Pad



FUJI 58 Gripper Pad



CD102 Gripper Pad



Gripper Pad



Gripper Pad



Gripper Pad



Gripper Pad



Gripper Pad



Gripper Pad



Gripper Pad



Gripper Pad

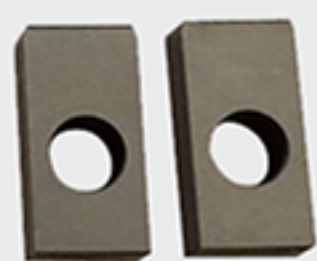

Mitsubishi 3F Gripper Pad



Gripper Pad



Spring/Retainer for Guide Strap GTO 46/52



Heidelberg SM52 Gripper



Gripper Pad



Gripper Pad



Gripper Pad



# Separator

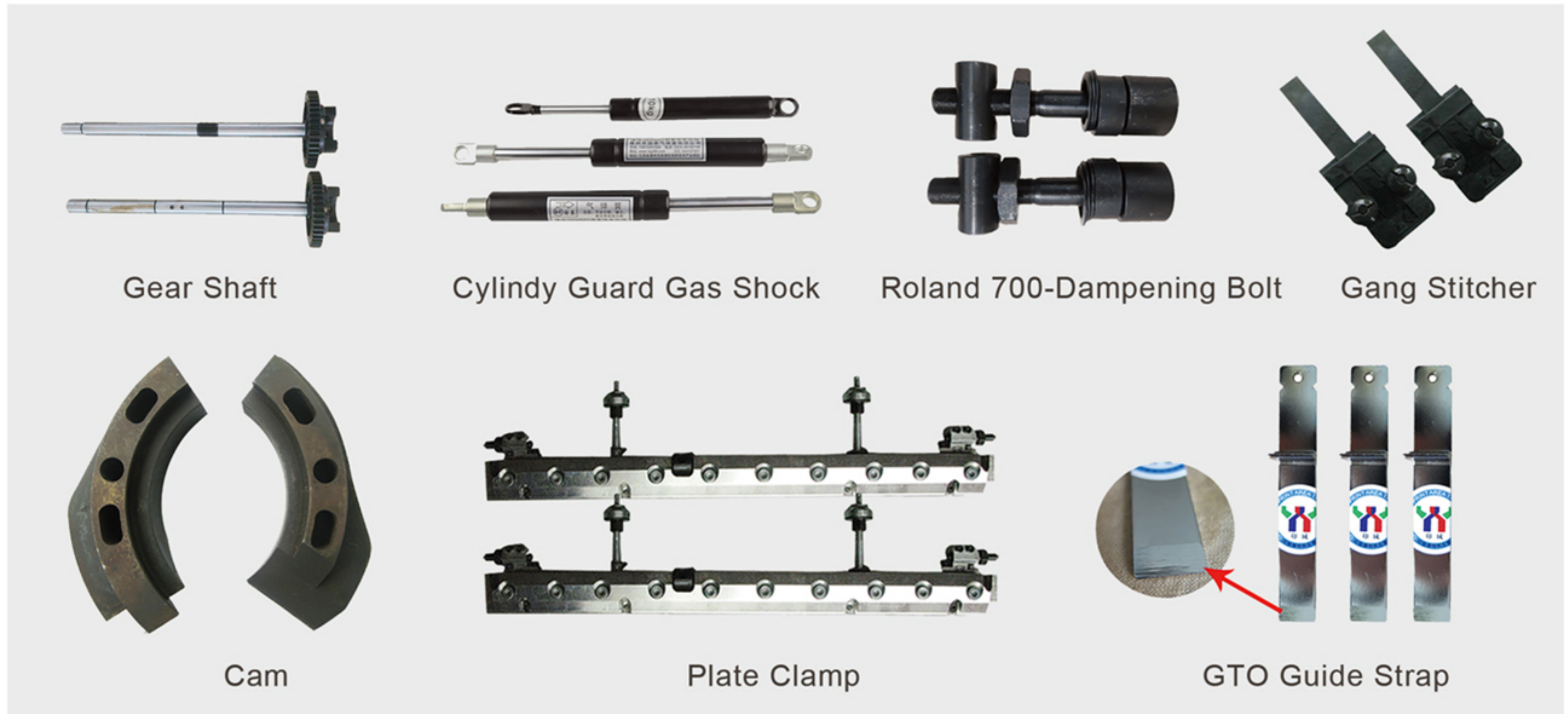

Gear Shaft

Cylindy Guard Gas Shock

Roland 700-Dampening Bolt

Gang Stitcher

Cam

Plate Clamp

GTO Guide Strap



Paper Folding Machine Lifting Sucker

Sucker Nozzle

Sucker Nozzle

Sucker Nozzle

Sucker Nozzle

Sucker Nozzle



Heidelberg SM74 Water Roller Nozzle

KBA74 Forwarding Sucker

Heidelberg SM74 Forwarding Sucker

KBA105 Forwarding Sucker

Heidelberg SM52 Forwarding Sucker



Sucker Nozzle

Gear

Spray Power Cup



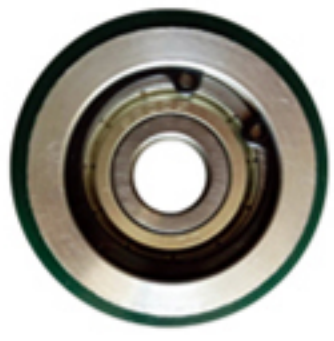

KBA72 Paper Wheel



Paper Wheel



Paper Wheel

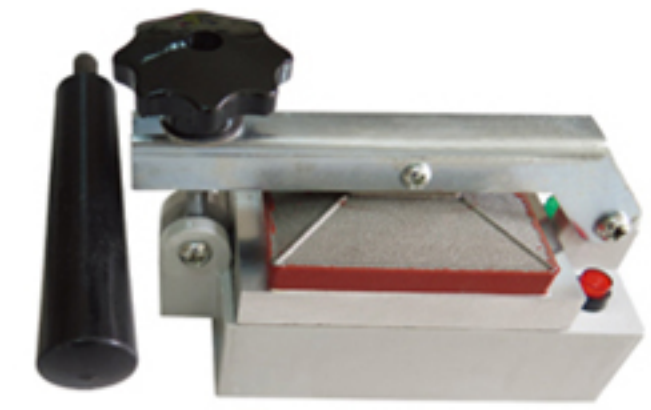

Belt Bonder



Heidelberg SM74 Fan



Fan



Heidelberg SM52  
Cam Follower



Heidelberg Potentiometer



Kodak CTP Plate  
Making Machine Motor



Heidelberg Pressure Motor



Mitsubishi Ink  
Key Motor

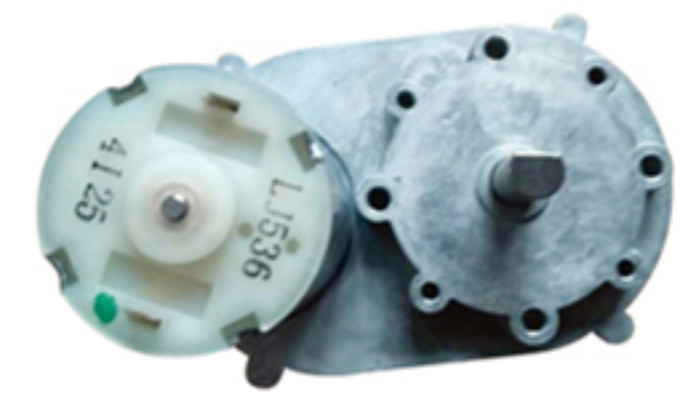

Shinohara 52 Motor



Mitsubishi Spring



Kord Spring



Kord Spring



Torsional Spring



Roland 200 Gripper



Komori Gripper Pad



Komori 26 Delivery Gripper



Gripper



Mitsubishi Shaft



Fuji Paper Wheel Supporter



Kord Spare Part



Kord Spare Part



Heidelberg SM74  
Festo Piston



Heidelberg Bellow



Latch Needle



Heidelberg SM102  
Air Sac Plate Clamp



**Air Filter** (All sizes could be customized)

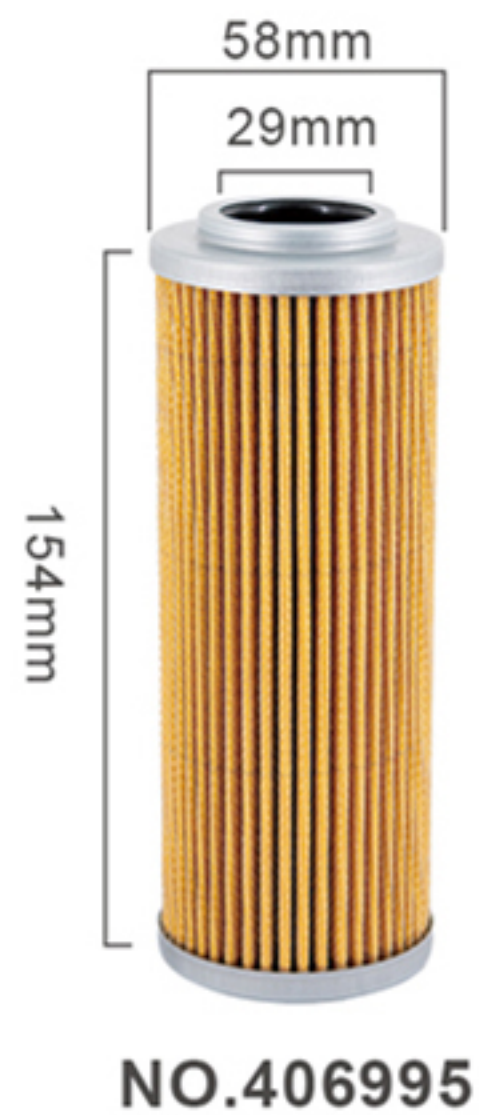
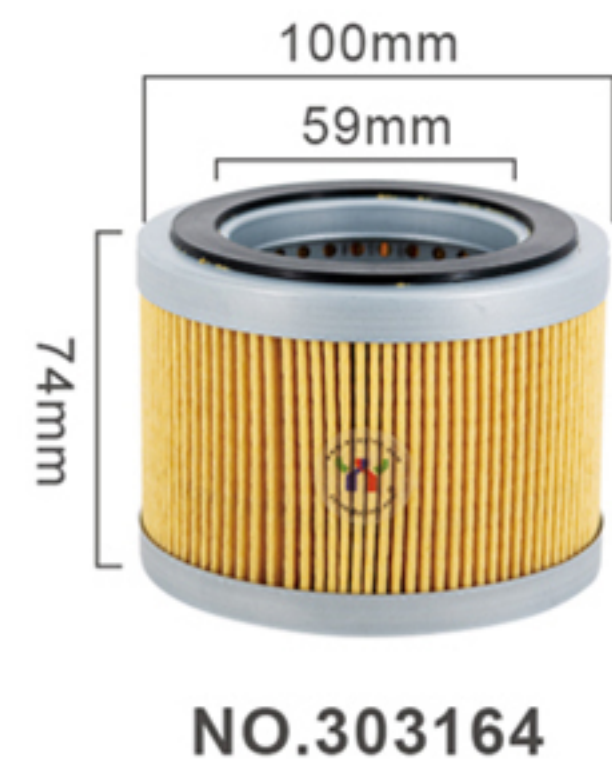

**Double Wire** (All sizes could be customized)

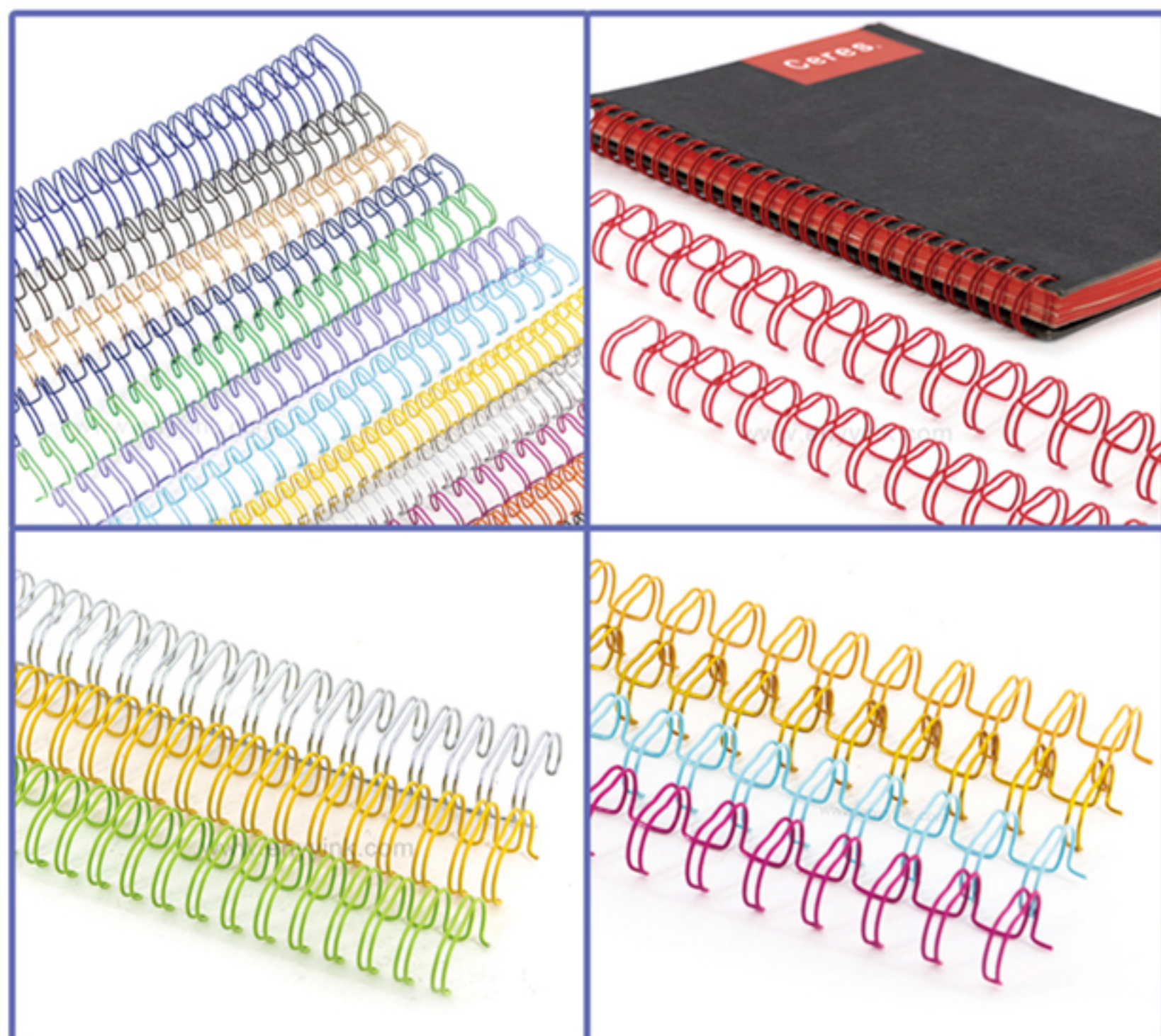

YYHB-520A SEMI-AUTOMATIC DOUBLE WIRE CLOSING MACHINE



# Company Profile



20+ Year Professional Experience In Printing Industry



160+ Countries Recognition



10000+ Customers Admire Our Service



## One-stop Printing Materials Supplier





# Our Friendship Lasts Forever

